



NetIQ® Identity Manager Driver for Lotus Notes Implementation Guide

March 2022

Legal Notice

For information about NetIQ trademarks, see <https://www.netiq.com/company/legal/>.

Copyright (C) 2019 NetIQ Corporation. All rights reserved.

Contents

About this Book and the Library	7
About NetIQ Corporation	9
1 Understanding the Lotus Notes Driver	11
Supported Lotus Notes Versions	11
Lotus Notes Driver Concepts	11
Default Data Flow	11
Policies	13
Driver Components	13
Support for Standard Driver Features	14
Remote Platforms	14
Entitlements	14
Password Synchronization Support	14
Data Synchronization Support	15
2 Installing the Driver Files	17
Installing the Driver Files	18
Copying ndsrep and notes.jar to the Required Locations	18
3 Creating a New Driver Object	23
Creating Lotus Notes Accounts and Groups	23
Creating the Driver Object in Designer	24
Importing the Current Driver Packages	24
Installing the Driver Packages	25
Configuring the Driver Object	28
Deploying the Driver Object	28
Starting the Driver	29
Starting ndsrep	30
Activating the Driver	31
Adding Packages to an Existing Driver	31
4 Upgrading an Existing Driver	33
Supported Upgrade Paths	33
What's New	33
What's New in Version 4.1.1.0	33
What's New in Version 4.0.1	33
Upgrading the Driver	33
Upgrading the Installed Packages	34
Applying the Driver Patch	34

5 Customizing the Driver	37
Determining Identity Vault Object Placement When a Notes Object is Moved	37
Automatically Determining Which Certifier to Use	39
Using Named Passwords	40
Using Driver Parameters	40
Driver Options	41
Subscriber Options	44
Publisher Options	51
Custom Driver Parameters	55
ACL Custom Parameters	74
mailfile Custom Parameters	77
Rep Custom Parameters	88
Example Files	91
Synchronizing a Database Other Than names.nsf	92
Schema Mapping Type and Form	93
Move/Rename	93
Subscriber Channel	93
Publisher Channel	95
Considerations for Using AdminP	95
TELL AdminP Commands	96
User.id Password Set	97
ID Vault Support	99
6 Managing the Driver	105
7 Troubleshooting the Driver	107
Troubleshooting Driver Processes	107
Troubleshooting Lotus Notes-Specific Items	107
Creating Lotus Notes Accounts and Groups	107
Troubleshooting Installation Problems	108
Driver Issues	109
A Driver Properties	111
Driver Configuration	111
Driver Module	112
Driver Object Password	112
Authentication	112
Startup Option	113
Driver Parameters	113
ECMAScript	116
Global Configuration	116
Global Configuration Values	116
Configuration	117
Wild Card Search Option	121
Entitlements	121
Password Synchronization	122
Account Status Support	123
Account Tracking	123

B Trace Levels	125
C ndsrep	127
Prerequisite for setting up ndsrep	127
Setting Up ndsrep	127
Initiating ndsrep	127
Loading ndsrep	128
Automated Method 1	128
Automated Method 2	128
Manual Method	128
Controlling ndsrep	129
Setting Up Multiple Instances of ndsrep	129
D Sample XDS Documents for Custom Parameters	131
Sample for Adding a User	131
Add Event Produced by the Identity Manager Engine	132
Add Event Received by the Notes Driver Shim	132
Sample for Renaming: Modifying a User Last Name	133
Modify Event Produced by the Identity Manager Engine	134
Modify Event Received by the Notes Driver Shim	134
Sample for Moving a User	135
Move Event Produced by the Identity Manager Engine	135
Move Event Received by the Notes Driver Shim	136
Sample for Deleting a User	136
Delete Event Produced by the Identity Manager Engine	137
Delete Event Received by the Notes Driver Shim	137
Samples for Sending a Command to the Domino Server Console	138
Domino Console Command Received by the Driver Shim	138
Command Response Returned by the Notes Driver Shim	138
Replication (Rep) Attribute Tags	139
The ADD Event Policy Rule for Database Replication	139
Mailfile Database Replication Attribute Tags That Are Submitted to the Shim	139
Sample Modify Event Policy Rule	141
Modify Event Attribute Tags That Are Submitted to the Shim	141
Sample ACL Entry Tags	142
ADD Event Policy Rule To Submit ACLEntry Parameters	142
Add Event ACLEntry Tags That Are Submitted To the Notes Driver Shim	142
Sample Modify Event Policy Rule	143
Modify Event As Submitted To the Notes Driver Shim	145
Setting and Modifying Lotus Notes Field Flags	146
Sample Creation Policy Rules	147
Sample Modify Policy Rule	147
Sample Add XDS Doc	147
Sample Modify XDS Doc	148

About this Book and the Library

The *Identity Manager Driver for Lotus Notes Implementation Guide* provides information for installing, configuring, and maintaining the Identity Manager Driver for Lotus Notes. This driver is designed to synchronize data in the Identity Vault with data stored in a Domino Directory or another Notes database. This configurable solution allows you to increase productivity and streamline business processes by integrating Lotus Notes with your other IT systems.

Intended Audience

This book provides information for individuals responsible for installing, configuring, and maintaining the Identity Manager Driver for Lotus Notes.

Other Information in the Library

For more information about the library for Identity Manager, see the following resources:

- ♦ [Identity Manager documentation website \(https://www.netiq.com/documentation/identity-manager-47/\)](https://www.netiq.com/documentation/identity-manager-47/)
- ♦ [Identity Manager drivers documentation website \(https://www.netiq.com/documentation/identity-manager-47-drivers/\)](https://www.netiq.com/documentation/identity-manager-47-drivers/)

About NetIQ Corporation

We are a global, enterprise software company, with a focus on the three persistent challenges in your environment: Change, complexity and risk—and how we can help you control them.

Our Viewpoint

Adapting to change and managing complexity and risk are nothing new

In fact, of all the challenges you face, these are perhaps the most prominent variables that deny you the control you need to securely measure, monitor, and manage your physical, virtual, and cloud computing environments.

Enabling critical business services, better and faster

We believe that providing as much control as possible to IT organizations is the only way to enable timelier and cost effective delivery of services. Persistent pressures like change and complexity will only continue to increase as organizations continue to change and the technologies needed to manage them become inherently more complex.

Our Philosophy

Selling intelligent solutions, not just software

In order to provide reliable control, we first make sure we understand the real-world scenarios in which IT organizations like yours operate—day in and day out. That's the only way we can develop practical, intelligent IT solutions that successfully yield proven, measurable results. And that's so much more rewarding than simply selling software.

Driving your success is our passion

We place your success at the heart of how we do business. From product inception to deployment, we understand that you need IT solutions that work well and integrate seamlessly with your existing investments; you need ongoing support and training post-deployment; and you need someone that is truly easy to work with—for a change. Ultimately, when you succeed, we all succeed.

Our Solutions

- ◆ Identity & Access Governance
- ◆ Access Management
- ◆ Security Management
- ◆ Systems & Application Management
- ◆ Workload Management
- ◆ Service Management

Contacting Sales Support

For questions about products, pricing, and capabilities, contact your local partner. If you cannot contact your partner, contact our Sales Support team.

Worldwide:	www.netiq.com/about_netiq/officelocations.asp
United States and Canada:	1-888-323-6768
Email:	info@netiq.com
Web Site:	www.netiq.com

Contacting Technical Support

For specific product issues, contact our Technical Support team.

Worldwide:	www.netiq.com/support/contactinfo.asp
North and South America:	1-713-418-5555
Europe, Middle East, and Africa:	+353 (0) 91-782 677
Email:	support@netiq.com
Web Site:	www.netiq.com/support

Contacting Documentation Support

Our goal is to provide documentation that meets your needs. The documentation for this product is available on the NetIQ Web site in HTML and PDF formats on a page that does not require you to log in. If you have suggestions for documentation improvements, click **Add Comment** at the bottom of any page in the HTML version of the documentation posted at www.netiq.com/documentation. You can also email Documentation-Feedback@netiq.com. We value your input and look forward to hearing from you.

Contacting the Online User Community

NetIQ Communities, the NetIQ online community, is a collaborative network connecting you to your peers and NetIQ experts. By providing more immediate information, useful links to helpful resources, and access to NetIQ experts, NetIQ Communities helps ensure you are mastering the knowledge you need to realize the full potential of IT investments upon which you rely. For more information, visit community.netiq.com.

1 Understanding the Lotus Notes Driver

The Identity Manager Driver for Lotus Notes lets you synchronize data in the Identity Vault with data stored in a Domino directory or another Notes database.

The Lotus Notes driver is essentially an application programming interface (API) translator that maps object data represented in an XML document between the Identity Vault and the appropriate Lotus Domino Toolkit for Java object methods.

- ♦ [“Supported Lotus Notes Versions” on page 11](#)
- ♦ [“Lotus Notes Driver Concepts” on page 11](#)
- ♦ [“Support for Standard Driver Features” on page 14](#)

Supported Lotus Notes Versions

You can use the Lotus Notes driver with Lotus Domino v8.5, v8.5.2, v8.5.3, v9.0.x, v10.01, v11.0.1 and v12.0.1.

NOTE: For Lotus Domino server v8.5.2 or later versions, you must add your driver authentication user account to the **Sign or run unrestricted methods and operations** parameter in the security page of the Domino server configuration document.

Lotus Notes Driver Concepts

The following sections explain concepts you should understand before implementing the Notes driver:

- ♦ [“Default Data Flow” on page 11](#)
- ♦ [“Policies” on page 13](#)
- ♦ [“Driver Components” on page 13](#)

Default Data Flow

A channel is a combination of rules, policies, and filters that is used to synchronize data between two systems. The Subscriber and Publisher channels describe the direction in which the data flows. The Subscriber and Publisher channels act independently; actions in one channel are not affected by what happens in the other.

- ♦ [“Subscriber Channel” on page 12](#)
- ♦ [“Publisher Channel” on page 12](#)

Subscriber Channel

The Subscriber channel is the channel of communication from the Identity Vault to Lotus Notes. The channel takes events generated in the Identity Vault and sends them to the Lotus Notes system. The following illustration shows this data flow:

Figure 1-1 Data Flow Through the Subscriber Channel

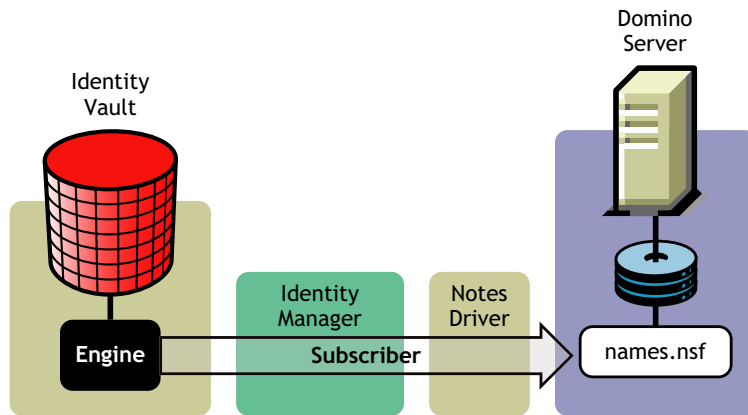

The driver can be configured to work with Notes databases other than the Public Address Book, `names.nsf`.

Publisher Channel

The Publisher channel represents the channel of communication from Lotus Notes to the Identity Vault. The channel takes event generated in Lotus Notes and sends them to the Identity Vault. The following illustration shows how this data is published:

Figure 1-2 Data Flow Through the Publisher Channel

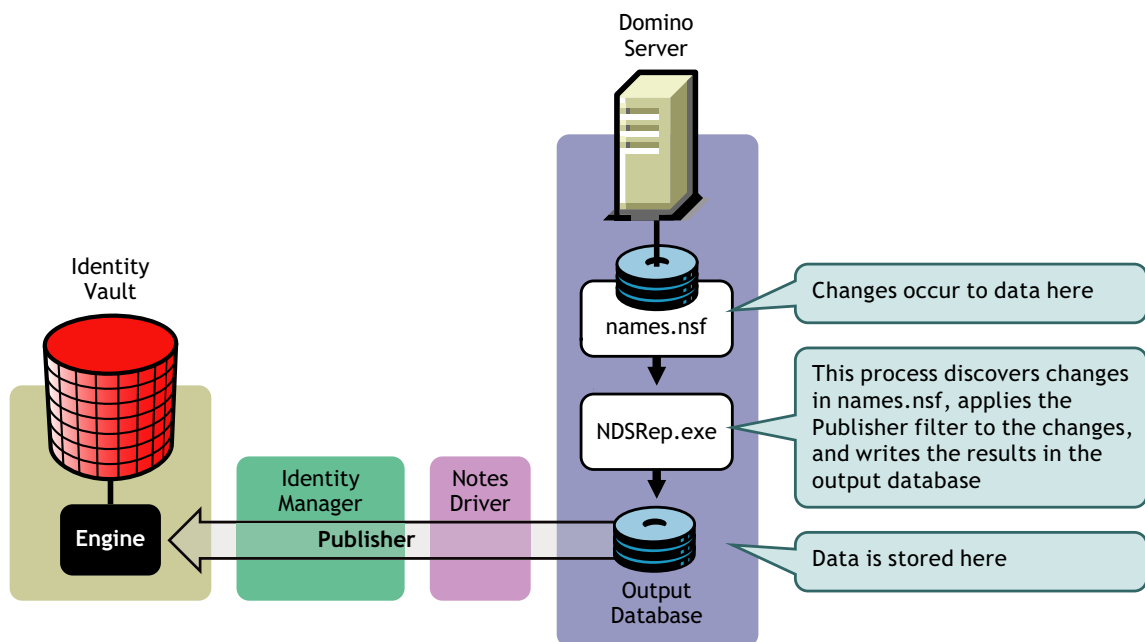

Policies

Policies are used to control the synchronization of data between the Identity Vault and Lotus Notes. Policies transform an event on a channel input into a set of commands on the channel output. The Lotus Notes driver includes the following set of preconfigured policies:

- ♦ **Schema Mapping:** Mappings have been defined for the Notes address book.
- ♦ **Creation:** The default Creation policy logic for the Publisher channel and the Subscriber channel is the same. Creating a User object requires a Given name and a Surname. Creating a Group object requires Description, Membership, and Owner attributes. You can modify these elements to meet your business policies.
- ♦ **Matching:** The default Matching policy logic for the Publisher channel and the Subscriber channel is the same. An Identity Vault User object is considered to be the same object in Notes when Given name and Surname match in both directories. An Identity Vault Group object is considered to be the same object in Notes when the CN is the same in both directories. You should modify these policies to meet your business policies. Matching policies are typically more specific than this generic Given name/Surname match.
- ♦ **Placement:** The default Placement policy on the Subscriber channel places all User objects from a specified Identity Vault container in a specified Notes Organizational Unit, and all Group objects from a specified Identity Vault container in a specified Organizational Unit in Notes. The same relationship is typically maintained on the Publisher channel. The container names and OU names for this default Placement policy are collected from the user when importing the default driver configuration. You should modify or add additional Placement policies and policy rules to meet your business needs.

Driver Components

The driver contains the following components:

- ♦ **Default Driver Configuration File:** A file you can import to set up default rules, style sheets, and driver parameters. The driver configuration file included with this driver is `Notes-IDM3_6-V4.xml`, with its accompanying `.xlf` file (for any language other than English).
- ♦ **Driver Files:** `CommonDriverShim.jar` and `NotesDriverShim.jar` are the Java files that direct synchronization between Lotus Notes and the Identity Vault.
- ♦ **notesdrvjni:** A shared library that provides Java Native Interface (JNI) access from `NotesDriverShim.jar` to Lotus Notes native libraries (Notes C APIs).
- ♦ **ndsrep:** A Lotus Domino server add-in process to enable data synchronization. It keeps track of the time of the last successful synchronization with a Notes database, and checks the Lotus Domino server for changes based on that time stamp. It then reads the changes from the Notes database, determines the event types they represent, and filters the updates based on objects and attributes specified in the Publisher filter in the driver configuration in the Identity Vault.
- ♦ **dsrepcfg.ntf:** A Notes database template required for the initial startup of the Notes driver shim. The Notes driver shim uses this Notes database template to create a configuration database named `dsrepcfg.nsf`, which is used by `ndsrep` to determine the Publisher filter and other driver publication settings.

Support for Standard Driver Features

The following sections provide information about how the Lotus Notes driver supports standard driver features:

- ♦ “Remote Platforms” on page 14
- ♦ “Entitlements” on page 14
- ♦ “Password Synchronization Support” on page 14
- ♦ “Data Synchronization Support” on page 15

Remote Platforms

IMPORTANT: The Lotus Notes Client is only supported on the workstation platforms. Identity Manager supports installing a 32-bit Lotus Notes Client with a 32-bit Remote Loader on the following workstation platforms:

- ♦ SLED (32-bit)
- ♦ RHEL 6 Client (32-bit)
- ♦ Windows 10 (64-bit)
- ♦ Windows 8 (64-bit)
- ♦ Windows 7 (64-bit)

In normal Identity Manager installations, the Remote Loader is supported only on the server platforms.

Install the Remote Loader and the driver on the workstation platform running the Lotus Notes Client. The Remote Loader enables the driver to communicate with the Identity Manager server.

For information about the operating systems supported for the Remote Loader, see [Identity Manager Technical Page \(https://www.netiq.com/Support/identity-manager/SP_IDM_Components.asp\)](https://www.netiq.com/Support/identity-manager/SP_IDM_Components.asp).

Entitlements

You can configure the Lotus Notes driver to use entitlements to manage user accounts and group membership in the Lotus Notes Address Book. When using entitlements, this driver works in conjunction with external services, such as the User Application with workflow or role-based provisioning or the Entitlements Service driver, to manage entitlement functionality.

The Notes driver also supports customized entitlements, if there are policies created for the driver to consume. For information about entitlements, see the [NetIQ Identity Manager Entitlements Guide](#).

Password Synchronization Support

The Notes driver synchronizes passwords only on the Subscriber channel.

Data Synchronization Support

The Notes driver synchronizes User objects and Group objects.

2 Installing the Driver Files

This section helps you plan the installation for the Notes driver. The driver uses the Remote Loader to communicate with Identity Manager engine and Lotus Notes Client to communicate with the Domino server. [Figure 2-1](#) depicts how you should install each component that contributes to data synchronization.

Figure 2-1 Remote Installation on a Notes Client Workstation

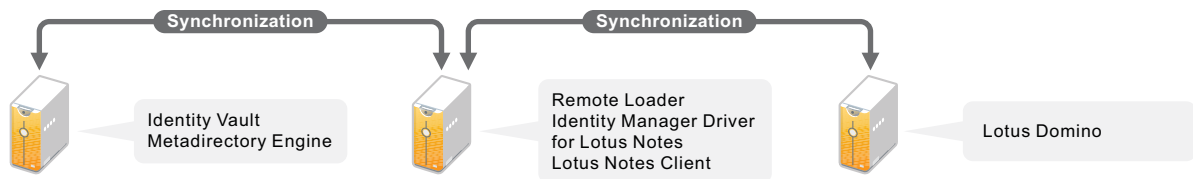

NetIQ recommends that you review the following considerations before starting the driver installation:

- ◆ Install Identity Manager engine and Identity Vault on the same server.
- ◆ Install Remote Loader, Lotus Notes driver, and the Lotus Notes Client on a separate server.
- ◆ Ensure that Notes Client and the Domino server have the same version. Otherwise, the driver might not work properly.
- ◆ NetIQ recommends that you install the Notes Client in a single-user environment only.
- ◆ NetIQ supports driver installation only on Windows XP, Windows 7, 8, or 10, SLED 11 (32-bit), or RHEL 6 Client 32-bit platform.

After you install Notes Client, ensure the following:

- ◆ Start Notes Client before starting the Lotus Notes driver. This allows the Notes Client to download the connection information from the Domino server required by the Notes driver. If you start the driver before starting the Notes Client, the driver might not start.
- ◆ Servers where Identity Manager server, the Notes Client, and the Domino server are installed have synchronized clocks so that Publisher events are properly cached. You must check this before starting the driver for the first time.

The following sections provide instructions for installing the driver files:

- ◆ [“Installing the Driver Files” on page 18](#)
- ◆ [“Copying ndsrep and notes.jar to the Required Locations” on page 18](#)

Installing the Driver Files

Complete the following steps for installing the Lotus Notes driver:

- 1 Install Identity Manager server. For instructions, see [Installing Identity Manager](#) in the [NetIQ Identity Manager Setup Guide for Linux](#) or [Installing Identity Manager Components](#) in the [NetIQ Identity Manager Setup Guide for Windows](#).
- 2 Install Remote Loader on a separate workstation where the Notes Client is already installed. For instructions, see [Installing Remote Loader](#) in the [NetIQ Identity Manager Driver Administration Guide](#).
You install the Lotus Notes driver as part of the Remote Loader installation.
- 3 Continue with [Copying ndsrep and notes.jar to the Required Locations](#) to complete installation of the files.

Copying ndsrep and notes.jar to the Required Locations

After the Lotus Notes driver files are installed, perform the following steps:

- 1 Manually copy the `ndsrep` and `dsrepcfg.ntf` files from the Windows or Linux ISO to the Domino server:

Filename	Copy from	Copy to
ndsrep	<p>The ISO location:</p> <p>32-Bit</p> <ul style="list-style-type: none"> ◆ \<ISO mounted location>\IDM\utilities\ndsrep\x86\windows ◆ \<ISO mounted location>\IDM\utilities\ndsrep\x86\linux ◆ \<ISO mounted location>\IDM\utilities\ndsrep\x86\AIX ◆ \<ISO mounted location>\IDM\utilities\ndsrep\x86\Solaris <p>64-Bit</p> <ul style="list-style-type: none"> ◆ \<ISO mounted location>\IDM\utilities\ndsrep\x64\linux ◆ \<ISO mounted location>\IDM\utilities\ndsrep\x64\windows ◆ \<ISO mounted location>\IDM\utilities\ndsrep\x64\AIX <p>NOTE: Identity Manager server installation is not supported on AIX and Solaris platforms. ndsrep is bundled in the product ISO so that you can copy the file to the Domino server installation folder on these operating systems. For information about operating systems and versions supported for the Domino server, see the IBM documentation web site. For information about Lotus Notes versions supported by the driver, see “Supported Lotus Notes Versions” on page 11.</p>	<p>The Domino server executable folder:</p> <ul style="list-style-type: none"> ◆ Windows: \Lotus\Domino ◆ Linux/Solaris/AIX: / local/notesdata
dsrepcfg.ntf	<p>The ISO location:</p> <p>\<ISO mounted location>\IDM\utilities\ndsrep\dsrepcfg.ntf</p>	<p>The Domino server data folder:</p> <ul style="list-style-type: none"> ◆ Windows: \Lotus\Domino\Data ◆ Linux/Solaris/AIX: /local/notesdata

For information about ndsrep, see [“Subscriber Channel” on page 12](#).

- 2 (Conditional) Manually copy the `Notes.jar` file from the Lotus Notes Client installation folder (`\Lotus\.\jvm\lib\ext`) to the Remote Loader folder (`C:\NetIQ\IDM\RemoteLoader\32bit\lib\`) on a Windows Client workstation.
This step is not applicable if the Notes driver is running on a Linux Client workstation.
- 3 If the Domino server requires databases to be signed, use a Notes Client or Domino Administrator to sign `dsrepcfg.ntf` with the server ID of your Domino server.
- 4 Ensure that the Notes Client library `.dll` directory (for example, `c:\lotus\notes`) is in the Windows system path, and reboot the system to make sure this step becomes effective.
If this directory is not in the Windows system path, the JVM might have difficulty locating the Notes Client libraries required by `Notes.jar`, such as `nlsxbe.dll`.
- 5 Ensure that the necessary `user.id` and `cert.id` files are available to the Notes Client and `NotesDriverShim.jar` so that the Notes driver can properly authenticate to the Domino server and register new Notes users.

If you are running the Notes Client on Linux, you must perform the initial client configuration after installing the Notes Client as a non-root user. Use the same non-root user to start and use the driver.

- 1 To start the driver from the non-root user's home directory, type the following command:

```
/opt/novell/eDirectory/lib/dirxml/rules/notes/rdxml.startnotes
```

- 2 To stop the driver from the non-root user's home directory, type the following command:

```
/opt/novell/eDirectory/lib/dirxml/rules/notes/rdxml.stoptnotes
```

The sample scripts and the sample configuration file are provided to demonstrate how to launch the driver. You can start the Remote Loader for the driver using `rdxml.startnotes`, and stop the Remote Loader for the driver using `rdxml.stoptnotes`. For more information, see [Table 2-1](#).

The sample scripts work in different situations. If they do not work in your environment, you might need to edit them appropriately. The sample scripts produce a Remote Loader trace log for the driver that can be used for troubleshooting.

- 3 Modify the scripts and configuration file to fit to your environment, as described in [Table 2-1](#).
- 4 Make sure that the three scripts noted in [Step 1](#) and [Step 2](#) have file access for execution (for example, `rwrx-r-x`).
- 5 Make sure that the `/local/notesdata/` directory is not present on the client workstation.

For troubleshooting tips, see [“Troubleshooting Installation Problems” on page 108](#).

Table 2-1 Sample Scripts and Sample Configuration

Filename	Description
<code>rdxml.startnotes</code>	<p>This script calls the <code>findDomino</code> script, which sets up appropriate operating system environment variables for the Notes driver. Then the <code>rdxml.startnotes</code> script launches the Remote Loader with the Notes driver parameters specified in the <code>rdxml.confignotes</code> file.</p> <p>If the location where the scripts are placed is not in a current search path, you might need to do one of the following:</p> <ul style="list-style-type: none">◆ Modify <code>rdxml.startnotes</code> to include a specific path to the <code>findDomino</code> script.◆ Create a symbolic link for <code>findDomino</code> in <code>/usr/bin</code>.
<code>rdxml.stopnotes</code>	<p>This script stops the Remote Loader that is running the Notes driver.</p>
<code>findDomino</code>	<p>This script is called from the <code>rdxml.startnotes</code> script. When you launch <code>rdxml.startnotes</code>, this script sets up operating system environment variables that indicate the location of a Linux type of installation of the Notes Client.</p>
<code>rdxml.confignotes</code> (or wherever your configuration is stored)	<p>This configuration is referenced by <code>rdxml.startnotes</code> and <code>rdxml.stopnotes</code> scripts.</p> <p>You might need to modify the <code>rdxml.startnotes</code> script to fit your environment. For example, if you change the name of the configuration file to a name other than <code>rdxml.confignotes</code>, you must revise the last line in the script.</p> <p>You might need to change the configuration ports that are referenced in this file.</p>

3 Creating a New Driver Object

After the Lotus Notes driver files are installed on the server where you want to run the driver (see [Chapter 2, “Installing the Driver Files,” on page 17](#)), you can create the driver in the Identity Vault. You do so by installing the driver packages and then modifying the driver configuration to suit your environment. The following sections provide instructions:

- ♦ [“Creating Lotus Notes Accounts and Groups” on page 23](#)
- ♦ [“Creating the Driver Object in Designer” on page 24](#)
- ♦ [“Activating the Driver” on page 31](#)
- ♦ [“Adding Packages to an Existing Driver” on page 31](#)

Creating Lotus Notes Accounts and Groups

The driver requires an account to access the Lotus Notes system. It also requires a Deny Access group to exist in the Lotus Notes system.

- 1 Create a Lotus Notes user account to be used exclusively by the driver. Do the following when you create the account:
 - ♦ Assign manager-level ACL access to the target Notes database (usually `names.nsf`), the output database (`ndsrep.nsf`) created by `ndsrep`, and `certlog.nsf`.
 - ♦ If you are synchronizing information from the Identity Vault to the Notes database (`names.nsf`), give the user all ACL roles (GroupCreator, GroupModifier, NetCreator, NetModifier, PolicyCreator, PolicyModifier, PolicyReader, ServerCreator, ServerModifier, UserCreator, UserModifier).
 - ♦ Assign access rights to the user account’s certifier ID file.
 - ♦ Assign access rights to the certifier ID files for the Notes certifiers that you want the driver to create users for.
 - ♦ (Optional) If you want the driver to be able to create new user certifier ID files, assign file access rights to the location where you want the driver to create the files.
- 2 If a Deny Access group doesn’t already exist, create this group by using the Lotus Domino Administrator tool.

This group is used to hold disabled user accounts.
- 3 The installation procedure should take care of Universal ID issues. If you are having problems with Universal IDs, see [“Creating Lotus Notes Accounts and Groups” on page 107](#).

Creating the Driver Object in Designer

You create a Lotus Notes driver object by installing the driver packages and then modifying the configuration to suit your environment. After you create and configure the driver, you need to deploy it to the Identity Vault and start it.

- ♦ [“Importing the Current Driver Packages” on page 24](#)
- ♦ [“Installing the Driver Packages” on page 25](#)
- ♦ [“Configuring the Driver Object” on page 28](#)
- ♦ [“Deploying the Driver Object” on page 28](#)
- ♦ [“Starting the Driver” on page 29](#)
- ♦ [“Starting ndsrep” on page 30](#)

Importing the Current Driver Packages

The driver packages contain the items required to create a driver, such as policies, entitlements, filters, and Schema Mapping policies. These packages are only available in Designer and can be updated after they are initially installed. You must have the most current version of the packages in the Package Catalog before you can create a new driver object.

To verify you have the most recent version of the driver packages in the Package Catalog:

- 1 Open Designer.
- 2 In the toolbar, click **Help > Check for Package Updates**.
- 3 Click **OK** to update the packages
or
Click **OK** if the packages are up-to-date.
- 4 In the Outline view, right-click the Package Catalog.
- 5 Click **Import Package**.

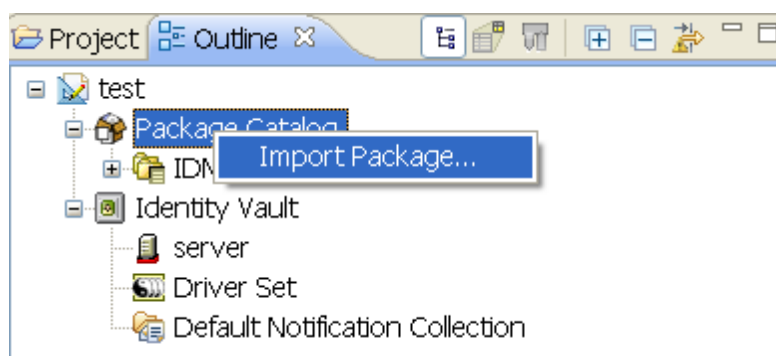

- 6 Select any Notes driver packages
or
Click **Select All** to import all of the packages displayed.
By default, only the base packages are displayed. Deselect **Show Base Packages Only** to display all packages.

- 7 Click **OK** to import the selected packages, then click **OK** in the successfully imported packages message.
- 8 After the current packages are imported, continue with [“Installing the Driver Packages” on page 25](#).

Installing the Driver Packages

After you have imported the current driver packages into the Package Catalog, you can install the driver packages to create a new driver.

- 1 In Designer, open your project.
- 2 In the Modeler, right-click the driver set where you want to create the driver, then click **New > Driver**.
- 3 Select **Notes Base**, then click **Next**.
- 4 Select the optional features to install for the Notes driver, then click **Next**. All options are selected by default.

The features are:

Default Configuration: This package contains the default configuration information for the Notes driver. Always leave this option selected.

Entitlements: These packages contain the policies and entitlements required to enable the driver for account creation and management with entitlements. For more information, see the [NetIQ Identity Manager Entitlements Guide](#).

Password Synchronization: This packages contains the policies that enable the Notes driver to synchronize passwords. If you want to synchronize passwords, verify that this option is selected. For more information, see the [NetIQ Identity Manager Password Management Guide](#).

Data Collection: These packages contain the policies that enable the driver to collect data for reports. If you are using Identity Reporting, verify that this option is selected. For more information, see the [Administrator Guide to NetIQ Identity Reporting](#).

Account Tracking: This group of packages contain the policies that enables account tracking information for reports. If you are using Identity Reporting, verify that this option is selected. For more information, see the [Administrator Guide to NetIQ Identity Reporting](#).

- 5 (Conditional) If there are package dependencies for the packages you selected to install, you must install them to install the selected package. Click **OK** to install the package dependency listed.
- 6 (Conditional) If more than one type of package dependency must be installed, you are presented with these packages separately. Continue to click **OK** to install any additional package dependencies.
- 7 (Conditional) On the Install Common Settings page, fill in the following fields, then click **Next**:
The Common Settings page is only displayed if the Common Settings package is installed as a dependency.

User Container: Select the Identity Vault container where the Notes accounts will be added if they don't already exist in the vault. This value becomes the default for all drivers in the driver set.

If you want a unique location for this driver, set the value for all drivers on this page. After the driver is created, change the value on the driver's Global Configuration Values page.

Group Container: Select the Identity Vault container where the Notes accounts will be added if they don't already exist in the vault. This value becomes the default for all drivers in the driver set.

If you want a unique location for this driver, set the value for all drivers on this page. After the driver is created, change the value on the driver's Global Configuration Values page.

8 On the Driver Information page, specify a name for the driver, then click **Next**.

9 On the Notes Base page, fill in the following fields, then click **Next**:

Notes User ID: Specify the Notes User ID the driver uses for authentication into the Notes system. The format of the name is the fully qualified canonical form. For example: CN=Notes Driver/O=Organization.

Notes User Password: Specify the password for the Notes User ID.

Domino Server: Specify the name of the Domino server the driver authenticates to. The format of the name is the fully qualified canonical form. For example: CN=NotesServer/O=Organization.

Notes Domain Name: Specify the Domino server domain name.

Notes Driver User ID File: Specify the Notes user ID file used by the Notes Driver to authenticate to Lotus Notes.

Domino Mail Server Name: Specify the name of the default mail server where mail files are created for users. The format of the name is the fully qualified canonical form. For example: CN=Domino1/O=Organization.

Mail File Template: Specify the name of the mailbox template database that is used to create new mail files users. This file name is different from each Domino version, and the file must be located in the Domino mail server's data directory. For example, if you are using Domino 8, the file name is `mail8.ntf`.

User Mail File Storage Location: Specify the user mail file storage location.

10 Fill in the following fields for Remote Loader information:

Connect To Remote Loader: Select **Yes** or **No** to determine if the driver will use the Remote Loader.

If you select **No**, skip to [Step 11](#). If you select **Yes**, use the following information to complete the configuration of the Remote Loader, then click **Next**:

Host Name: Specify the IP address or DNS name of the server where the Remote Loader is installed and running.

Port: Specify the port number for this driver. Each driver connects to the Remote Loader on a separate port. The default value is 8090.

Remote Loader Password: Specify a password to control access to the Remote Loader. It must be the same password that is specified as the Remote Loader password on the Remote Loader.

Driver Password: Specify a password for the driver to authenticate with the Identity Manager server. It must be the same password that is specified as the Driver Object Password on the Remote Loader.

11 (Conditional) On the Install Notes Managed System Information page, fill in the following fields to define your Notes system, then click **Next**:

The page is displayed only if you selected to install the Data Collection packages and the Account Tracking packages.

Name: Specify a descriptive name for this Notes system. The name is displayed in reports.

Description: Specify a brief description for this Notes system. The description is displayed in reports.

Location: Specify the physical location of this Notes system. The location is displayed in reports.

Vendor: Leave Microsoft as the vendor of Notes. This information is displayed in reports.

Version: Specify the version of this Notes system. The version is displayed in the reports.

- 12** (Conditional) On the Install Notes Managed System Information page, fill in the following fields to define the ownership of the Notes system, then click **Next**:

The page is displayed only if you selected to install the Data Collection and the Account Tracking packages.

Business Owner: Select a user object in the Identity Vault that is the business owner of the Notes system. This can only be a user object, not a role, group, or container.

Application Owner: Select a user object in the Identity Vault that is the application owner of the Notes system. This can only be a user object, not a role, group, or container.

- 13** (Conditional) On the Install Notes Managed System Information page, fill in the following fields to define the classification of the Notes system, then click **Next**:

The page is displayed only if you selected to install the Data Collection and the Account Tracking packages.

Classification: Select the classification of the Notes system. This information is displayed in the reports. Your options are:

- ◆ Mission-Critical
- ◆ Vital
- ◆ Not-Critical
- ◆ Other

If you select **Other**, you must specify a custom classification for the Notes system.

Environment: Select the type of environment the Notes system provides. The options are:

- ◆ Development
- ◆ Test
- ◆ Staging
- ◆ Production
- ◆ Other

If you select **Other**, you must specify a custom classification for the Notes system.

- 14** On the Account Status page, fill in the following fields, then click **Next**:

Use Deny Access Group for Account Status: Select whether to place disabled user accounts into a Notes Deny Access Group.

Deny Access Group Name: Specify the Notes Deny Access Group where the driver places users when the user account is disabled.

- 15** Review the summary of tasks that will be completed to create the driver, then click **Finish**.

- 16** After you have installed the driver, you must change the configuration for your environment. Proceed to [“Configuring the Driver Object” on page 28](#).

Configuring the Driver Object

The Notes driver is operational after the driver packages are installed. However, the basic configuration might not meet the requirements for your environment. You should complete the following tasks to configure the driver:

- ♦ **Ensure that the driver can authenticate to Lotus Notes:** Make sure that you have established a Lotus Notes user account for the driver (see [“Creating Lotus Notes Accounts and Groups” on page 23](#)) and the correct authentication information is defined for the driver parameters (see [“Authentication” on page 112](#)).
- ♦ **Configure the driver parameters:** There are many settings that can help you customize and optimize the driver. The settings are divided into categories such as Driver Configuration, Engine Control Values, and Global Configuration Values (GCVs). Although it is important for you to understand all of the settings, your first priority should be to configure the driver parameters located on the Driver Configuration page. The driver parameters control general settings such as the certifier file and Lotus Notes database accessed by the driver, Subscriber channel settings, and Publisher channel settings. For information about the driver parameters, see [“Driver Parameters” on page 113](#). For additional information, see [“Using Driver Parameters” on page 40](#).
- ♦ **Configure the driver filter:** Modify the driver filter to include the object classes and attributes you want synchronized between the Identity Vault and Lotus Notes.
- ♦ **Configure policies:** Modify the policies as needed. For information about the default configuration policies, see [“Policies” on page 13](#).
- ♦ **Configure password synchronization:** The basic driver configuration is set up to support password synchronization through Universal Password. If you don't want this setup, see [“Configuring Password Flow”](#) in the *NetIQ Identity Manager Password Management Guide*.

After completing the configuration tasks, continue with the next section, [Deploying the Driver Object](#).

Deploying the Driver Object

After the driver object is created in Designer, it must be deployed into the Identity Vault.

- 1 In Designer, open your project.
- 2 In the Modeler, right-click the driver icon  or the driver line, then select **Live > Deploy**.
- 3 If you are authenticated to the Identity Vault, skip to [Step 4](#); otherwise, specify the following information, then click **OK**:
 - Host:** Specify the IP address or DNS name of the server hosting the Identity Vault.
 - Username:** Specify the DN of the user object used to authenticate to the Identity Vault.
 - Password:** Specify the user's password.
- 4 Read the deployment summary, then click **Deploy**.
- 5 Read the message, then click **OK**.
- 6 Click **Define Security Equivalence** to assign rights to the driver.

The driver requires rights to objects within the Identity Vault. The Admin user object is most often used to supply these rights. However, you might want to create a DriversUser (for example) and assign security equivalence to that user.

6a Click **Add**, then browse to and select the object with the correct rights.

6b Click **OK** twice.

For more information about defining a Security Equivalent User in objects for drivers in the Identity Vault, see “Establishing a Security Equivalent User” in the [NetIQ Identity Manager Security Guide](#).

7 Click **Exclude Administrative Roles** to exclude users that should not be synchronized.

You should exclude any administrative User objects (for example, Admin and DriversUser) from synchronization.

7a Click **Add**, then browse to and select the user object you want to exclude, click **OK**.

7b Repeat [Step 7a](#) for each object you want to exclude.

7c Click **OK**.

8 Click **OK**.

Starting the Driver

When a driver is created, it is stopped by default. To make the driver work, you must start the driver and cause events to occur. Identity Manager is an event-driven system, so after the driver is started, it won't do anything until an event occurs.

To start the driver:

1 If you are using the Remote Loader with the driver, make sure the Remote Loader driver instance is running:

- ♦ **Windows:** Open the Remote Loader console on the driver's server, select the driver in the list, then click **Start**.

IMPORTANT: To start, stop, or edit the driver service, run the Remote Console utility as an administrator. Right-click the Remote Loader shortcut icon and select **Run as administrator** in the menu that displays. Alternatively, click Ctrl+Shift+Click keys from the keyboard.

- ♦ **Linux:** At the server command line, add the driver object password and Remote Loader password to the Notes driver startup script. For example:

```
cd driver_script_directory
./rdxml.startnotes -sp driver_password remote_loader_password
```

These passwords must be the same as the “[Driver Object Password](#)” on page 112 and “[Remote Loader Password:](#)” on page 113 you specified when configuring the driver. The `driver_script_directory` should be the directory where you placed the files (see “[Copying ndsrep and notes.jar to the Required Locations](#)” on page 18).

Use `rdxml.startnotes` to start the Remote Loader for the driver.

For example,

```
cd driver_script_directory
./rdxml.startnotes
```

- 2 In Designer, open your project.
- 3 In the Modeler, right-click the driver icon  or the driver line, then select **Live > Start Driver**.

When the driver starts for the first time, it does the following:

- ♦ Searches for the Domino server (specified in the [driver parameters](#)).
- ♦ Opens `dsrepcfg.nsf`. If that file does not exist, the driver automatically creates `dsrepcfg.nsf`, using the `dsrepcfg.ntf` database template that is provided with the driver.
- ♦ Writes the Publisher parameters and data to `dsrepcfg.nsf`, specifying an appropriate update database file (usually named `ndsrep.nsf`), so that `ndsrep` can read them.

If multiple `notes.ini` files exist on the computer running the driver, ensure that the Notes driver shim uses the correct `.ini` by placing its directory in the OS search path. If the driver shim initializes with the wrong `notes.ini` file, the driver shim cannot open `dsrepcfg.ntf`.

If `dsrepcfg.ntf` is not found, or the initial `dsrepcfg.nsf` creation process fails, then the Publisher channel shuts down.

Ensure that the driver shim initializes properly by modifying the Windows system path to find the appropriate `notes.ini` file.

- 4 Continue with the next section, [Starting ndsrep](#).

Starting ndsrep

The `ndsrep` program is used to publish information from the Notes database to the Identity Vault (Publisher channel). It is not required if you are only sending information from the Identity Vault to the Notes database (Subscriber channel).

`Ndsrep` is a Lotus Domino server add-in process to enable data synchronization. It keeps track of the time of the last successful synchronization with a Notes database, and checks the Lotus Domino server for changes based on that time stamp. It then reads the changes from the Notes database, determines the event types they represent, and filters the updates based on objects and attributes specified in the Publisher filter in the driver configuration in the Identity Vault.

You should have already copied `ndsrep` to the Lotus Domino server (see [“Copying ndsrep and notes.jar to the Required Locations” on page 18](#)).

- 1 At the Domino Console, start the `ndsrep` task:

```
load ndsrep instance
```

The *instance* must be the driver name, or a unique instance name set up for this driver. If the name of your driver includes spaces, you must put quotes around the name. After `ndsrep` is loaded, all `TELL` commands are issued to this instance of `ndsrep` using the instance name.

A task named `NDSREP-instance` is now displayed in the Notes Task Viewer.

- 2 After the initial configuration and startup have been validated, update the Domino server's `notes.ini` file so that `ndsrep` is loaded automatically.

For example:

```
ServerTasks=Update,Replica,Router,AMgr,AdminP,ndsrep notesdrv1,  
CalConn,Sched,HTTP,IMAP,POP3
```

If the name of your driver includes spaces, you must put quotes around the name.

After the first successful startup, the Notes driver and ndsrep can be launched in any order that is convenient for your particular configuration.

For additional information about using ndsrep, see [Appendix C, “ndsrep,” on page 127](#).

Activating the Driver

The Identity Manager driver for Lotus Notes does not need a separate activation. If you create the driver in a driver set where you have already activated the Identity Manager server and service drivers, the driver inherits the activation from the driver set.

If you create the driver in a driver set that has not been previously activated, the driver will run in the evaluation mode for 90 days. You must activate the driver during the evaluation period; otherwise, the driver will be disabled. If you try to run the driver, the trace displays an error message indicating that you need to reactivate the driver to use it. For information on activation, refer to [Activating Identity Manager](#) in the *NetIQ Identity Manager Overview and Planning Guide*.

Adding Packages to an Existing Driver

You can add new functionality to an existing driver by adding new packages to an existing driver.

- 1 Right-click the driver, then click **Properties**.
- 2 Click **Packages**, then click the **Add Packages** icon **+**.
- 3 Select the packages to install. If the list is empty, there are no available packages to install.
- 4 (Optional) Deselect the **Show only applicable package versions** option, if you want to see all available packages for the driver, then click **OK**.

This option is only displayed on drivers. By default, only the packages that can be installed on the selected driver are displayed.

- 5 Click **Apply** to install all of the packages listed with the Install operation.

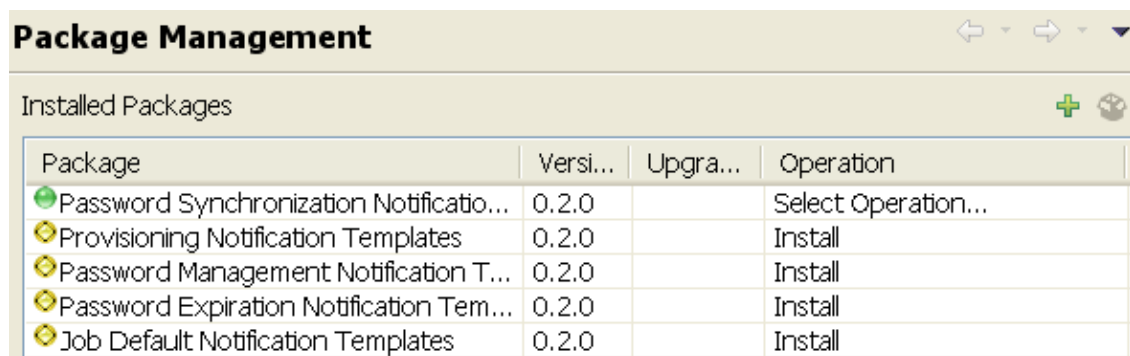

- 6 (Conditional) Fill in the fields with appropriate information to install the package you selected for the driver, then click **Next**.
- 7 Read the summary of the installation, then click **Finish**.
- 8 Click **OK** to close the Package Management page after you have reviewed the installed packages.

Package Management			
Installed Packages			
Package	Versi...	Upgra...	Operation
Job Default Notification Templates	0.2.0		Select Operation...
Password Expiration Notification Tem...	0.2.0		Select Operation...
Password Management Notification T...	0.2.0		Select Operation...
Password Synchronization Notificatio...	0.2.0		Select Operation...
Provisioning Notification Templates	0.2.0		Select Operation...

- Repeat [Step 1](#) through [Step 8](#) for each driver where you want to add the new packages.

4 Upgrading an Existing Driver

The following sections provide information to help you upgrade an existing driver:

- ♦ [“Supported Upgrade Paths” on page 33](#)
- ♦ [“What’s New” on page 33](#)
- ♦ [“Upgrading the Driver” on page 33](#)

Supported Upgrade Paths

You can upgrade from any 3.x version of the Lotus Notes driver. Upgrading a pre-3.x version of the driver directly to version 4.0 or later is not supported.

What’s New

- ♦ [What’s New in Version 4.1.1.0](#)
- ♦ [What’s New in Version 4.0.1](#)

What’s New in Version 4.1.1.0

This version of the driver allows you to specify the key strength to encrypt the UserID file. You can use the key strength from the Domino server. Otherwise, manually select the key strength from the given options. For more information, see [Specify User Key Strength](#) from [“Subscriber Settings” on page 114](#).

What’s New in Version 4.0.1

This version of the driver does not include any new features.

Upgrading the Driver

The driver upgrade process involves upgrading the installed driver packages and the driver files.

This section provides general instructions for updating a driver. For information about updating the driver to a specific version, search for that driver patch in the [NetIQ Patch Finder Download Page](#) and follow the instructions from the Readme file accompanying the driver patch release.

- ♦ [“Upgrading the Installed Packages” on page 34](#)
- ♦ [“Applying the Driver Patch” on page 34](#)

Upgrading the Installed Packages

- 1 Download the latest available packages.

To configure Designer to automatically read the package updates when a new version of a package is available, click **Windows > Preferences > NetIQ > Package Manager > Online Updates** in Designer. For more information about managing packages, see the [NetIQ Designer for Identity Manager Administration Guide](#).

- 2 Upgrade the installed packages.

- 2a Open the project containing the driver.

- 2b Right-click the driver for which you want to upgrade an installed package, then click **Driver > Properties**.

- 2c Click **Packages**.

If there is a newer version of a package, there is check mark displayed in the Upgrades column.

- 2d Click **Select Operation** for the package that indicates there is an upgrade available.

- 2e From the drop-down list, click **Upgrade**.

- 2f Select the version that you want to upgrade to, then click **OK**.

NOTE: Designer lists all versions available for upgrade.

- 2g Click **Apply**.

- 2h (Conditional) Fill in the fields with appropriate information to upgrade the package, then click **Next**.

Depending on which package you selected to upgrade, you must fill in the required information to upgrade the package.

- 2i Read the summary of the packages that will be installed, then click **Finish**.

- 2j Review the upgraded package, then click **OK** to close the Package Management page.

For detailed information, see the [Upgrading Installed Packages](#) in [NetIQ Designer for Identity Manager Administration Guide](#).

Applying the Driver Patch

The driver patch updates the driver files. You can install the patch as a `root` or `non-root` user.

- ♦ [“Prerequisites” on page 34](#)
- ♦ [“Applying the Patch as a Root User” on page 35](#)
- ♦ [“Applying the Patch as a Non-Root User” on page 35](#)

Prerequisites

Before installing the patch, complete the following steps:

- 1 Take a back-up of the current driver configuration.
- 2 Stop the Remote Loader and the driver instance.
- 3 In a browser, navigate to the [NetIQ Patch Finder Download Page](#).

- 4 Under **Patches**, click **Search Patches**.
- 5 Specify **Identity Manager *nn* Notes Driver *nn*** in the search box.
- 6 Download and unzip the contents of the patch file to a temporary location on your server.
For example, `IDM45_Notes_4010.zip`.

Applying the Patch as a Root User

In a root installation, the driver patch installs the driver files RPMs in the default locations on Linux. On Windows, you need to manually copy the files to the default locations.

- 1 Ensure that you have completed the prerequisites for installing the patch. For more information, see [“Prerequisites” on page 34](#).
- 2 On the server where you want run the patch, log in as `root`.
- 3 Depending on your platform, perform one of the following actions:

- ♦ **Linux:** Run the following command in a terminal window:

```
rpm -Uvh <Driver Patch File Temporary Location>/linux/novell-DXMLnotes.rpm
```

For example, `rpm -Uvh <IDM45_Notes_4010.zip>/linux/novell-DXMLnotes.rpm`

- ♦ **Windows:** Navigate to the `<Extracted Driver Patch File Temporary Location>\windows` folder and copy the `NotesDriverShim.jar` file to your driver installation folder.

For example, `<IdentityManager installation>\RemoteLoader\<architecture>\lib`

- 4 (Conditional) On Linux, create a soft link to point to the `Notes.jar` file.

This is required for the driver to start.

- ♦ **Notes Client 9.0.x:** Run the following command in a terminal window:

```
ln -fs /opt/ibm/notes/jvm/lib/ext/Notes.jar /opt/novell/eDirectory/lib/dirxml/classes/Notes.jar
```

- ♦ **Notes Client earlier than 9.0:** Run the following command in a terminal window:

```
ln -fs /opt/ibm/lotus/notes/jvm/lib/ext/Notes.jar /opt/novell/eDirectory/lib/dirxml/classes/Notes.jar
```

- 5 (Conditional) On Windows, Solaris and AIX, copy `ndsrep` from the `<Extracted Driver Patch File Temporary Location>\ndsrep\<platform>\architecture` folder to the `/local/notesdata` directory specific to the architecture of your Domino Server.
- 6 Start the Domino server.
- 7 Start the Remote Loader and the driver instance.

Applying the Patch as a Non-Root User

- 1 Verify that `<non-root eDirectory location>/rpm` directory exists and contains the file, `_db.000`.

The `_db.000` file is created during a non-root installation of the Identity Manager engine. Absence of this file might indicate that Identity Manager is not properly installed. Reinstall Identity Manager to correctly place the file in the directory.

- 2 To set the `root` directory to the location of non-root Identity Vault, enter the following command in the command prompt:

```
ROOTDIR=<non-root eDirectory location>
```

This will set the environmental variables to the directory where Identity Vault is installed as a non-root user.

- 3 To install the driver files, enter the following command:

```
rpm --dbpath $ROOTDIR/rpm -Uvh --relocate=/usr=$ROOTDIR/opt/novell/  
eDirectory --relocate=/etc=$ROOTDIR/etc --relocate=/opt/novell/  
eDirectory=$ROOTDIR/opt/novell/eDirectory --relocate=/opt/novell/  
dirxml=$ROOTDIR/opt/novell/dirxml --relocate=/var=$ROOTDIR/var --  
badreloc --nodeps --replacefiles <rpm-location>
```

For example, to install the Lotus Notes driver RPM, use this command:

```
rpm --dbpath $ROOTDIR/rpm -Uvh --relocate=/usr=$ROOTDIR/opt/novell/  
eDirectory --relocate=/etc=$ROOTDIR/etc --relocate=/opt/novell/  
eDirectory=$ROOTDIR/opt/novell/eDirectory --relocate=/opt/novell/  
dirxml=$ROOTDIR/opt/novell/dirxml --relocate=/var=$ROOTDIR/var --  
badreloc --nodeps --replacefiles /home/user/novell-DXMLnotes.rpm
```

5 Customizing the Driver

This section explains how to customize your driver for your specific business rules.

- ♦ [“Determining Identity Vault Object Placement When a Notes Object is Moved” on page 37](#)
- ♦ [“Automatically Determining Which Certifier to Use” on page 39](#)
- ♦ [“Using Named Passwords” on page 40](#)
- ♦ [“Using Driver Parameters” on page 40](#)
- ♦ [“Custom Driver Parameters” on page 55](#)
- ♦ [“Example Files” on page 91](#)
- ♦ [“Synchronizing a Database Other Than names.nsf” on page 92](#)
- ♦ [“Schema Mapping Type and Form” on page 93](#)
- ♦ [“Move/Rename” on page 93](#)
- ♦ [“TELL AdminP Commands” on page 96](#)
- ♦ [“User.id Password Set” on page 97](#)
- ♦ [“ID Vault Support” on page 99](#)

NOTE: When you customize data synchronization, you must work within the supported standards and conventions for the operating systems and accounts being synchronized. Data containing characters that are valid in one environment, but invalid in another, causes errors.

Determining Identity Vault Object Placement When a Notes Object is Moved

A Move is done by Identity Manager relative to either a parent’s association key or `dest-dn`. Containment in Notes is purely logical, and as such, an OU in Notes never has an association to the Identity Vault, so it isn’t possible to provide a parent association. Also, the driver shim has no reference of the Identity Vault namespace or containment, so it can’t provide a parent `dest-dn` (destination DN). Therefore, an appropriate parent `dest-dn` must be provided by a policy.

Notes - Move Sample is a sample Publisher channel policy that contains logic to determine Identity Vault object placement when an associated Notes object is moved.

This policy is designed to provide the same functionality contained in the sample style sheet named `placemove.xml`, provided with earlier versions of the driver. A sample configuration is also available with in `NotesConfig21.xml`, which demonstrates the driver object’s `move` and `rename` capabilities.

On a move, the `dest-dn` is set for a particular source `dn`. After importing the Notes - Move Sample policy, you have a policy defining a single mapping between source and destination containers. You can define additional mappings by editing the resulting policy.

NOTE: Because of the way Notes manages CN and DN in FullName, it is not possible to distinguish between a Move and a Rename event in ndsrep. Therefore, when ndsrep determines that the FullName item has changed, it generates both a Move and a Rename event.

To add the Notes - Move Sample policy to your driver configuration:

- 1 In iManager, click **Identity Manager Utilities > Import Drivers**.
- 2 Select the driver set where your existing driver resides.
- 3 In the list of driver configurations that appears, scroll down to the **Additional Policies** heading, then select only the item labeled **Notes - Move Sample**. Click **Next**.

A list of import prompts appears.

- 4 Select the name of your existing Notes driver.
- 5 Specify one container in Notes and the corresponding container in the Identity Vault:
The import process uses this information to create one pair of “mappings” between Notes containers and Identity Vault containers.

5a Specify the source container from Notes where the move originates.

For example, \MyOrganization\Engineering\Testing.

5b Browse for and select the destination container where the object should be moved to.

For example, Testing.MyOrganization.

- 6 Click **Next**.

A page appears with the message A driver named *your_driver_name* already exists in the driver set. Select one of the options below.

- 7 Select the following:
 - ◆ **Update Only Selected Policies in That Driver**
 - ◆ **Move Sample (Subscriber - DirXML Script)**

- 8 Click **Next**, then click **Finish** to complete the wizard.

At this point, the new policy has been created as a policy object under the driver object, but is not yet part of the driver configuration. To link it in, you must manually insert it into a policy set.



- 9 Insert the new policy into a policy set on the Publisher channel:

Place it where it would be appropriate in your driver configuration. For example, in the Input Transformation or Event Transformation policy set.

9a Click **Identity Manager > Identity Manager Overview**. Select the driver set for the driver you are updating.

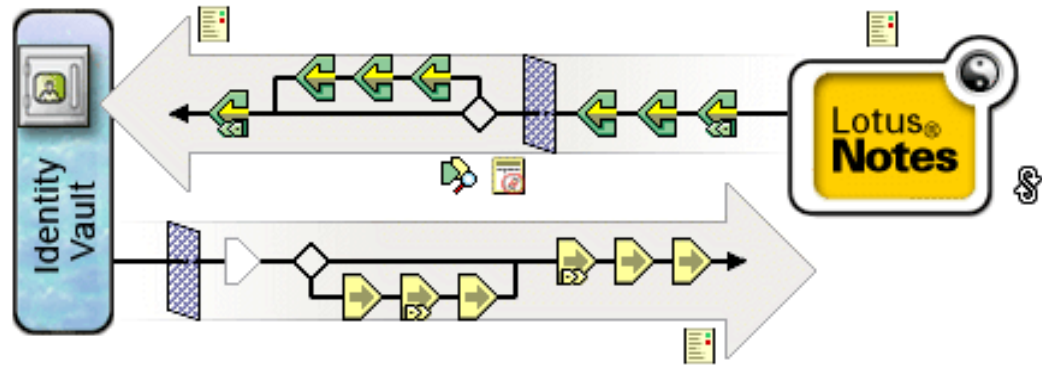
9b Click the driver you just updated. A page opens, showing a graphical representation of the driver configuration.



- 9c Click the icon for the policy set on the Publisher Channel.
- 9d Click the **Plus** button to add the new policy. In the Create Policy page, click **Make a copy of an existing policy**, then browse for and select the new policy object. Click **OK**.
- 9e If you have more than one policy in the policy set, use the arrow buttons   to move the new policy to the correct location in the list.
- 10 Complete the “mappings” for all the containers in Notes and Identity Vault by editing the XML for the policy.

Follow the example of the first pair that is created for you with the container names you provided in [Step 5](#).

Automatically Determining Which Certifier to Use

Because most Notes environments use more than one certifier, you can use a policy to configure the Notes driver shim to use different certifiers. The sample `Cert.xsl` style sheet, located in the `windows\setup\drivers\lotusNotes\rules` directory on the Identity Manager DVD or the Identity Manager Windows CD, is an Output Transformation style sheet that contains logic to determine which Lotus Notes Certifier to use based on the `src-dn` attribute on the `<add>` XML attribute. Another example provided is the `NotesCertifierSelectionSampleSS.xsl` sample style sheet and in the file `NotesConfig21.xml`. (These are installed on Linux.)

You can edit the `choose/when` statements to model your Notes system Certifier structure. If using only the root certifier is acceptable, then using `Cert.xsl` is not necessary, because the driver parameters screen can contain the information for the root certifier.

To use `Cert.xsl` in your environment, first, change the existing `xsl:when` statements to match your configuration.

```
<xsl:when test="string($dn) = '\dirxml-ds\provo\notes\eng' ">
  <xsl:attribute name="cert-id">c:\lotus\notes\data\eng.id</xsl:attribute>
  <xsl:attribute name="cert-pwd">certify2eng</xsl:attribute>
  <xsl:attribute name="user-pwd">new2notes</xsl:attribute>
</xsl:when>
```

Add as many `xsl:when` statements as you need to model your organization’s certification structure.

Then change the `cert-id` and `cert-pwd` in `xsl:otherwise` to match your root certifier information.

```
<xsl:otherwise>
  <xsl:attribute name="cert-id">d:\lotus\domino\data\cert.id</
xsl:attribute>
  <xsl:attribute name="cert-pwd">certify2notes</xsl:attribute>
</xsl:otherwise>
```

Cert.xsl communicates the certifier information by adding attributes to the add tag in the XML document. If Notes driver shim doesn't find these attributes, it uses the root certifier information from the driver Parameters passed during initialization.

NOTE: Cert.xsl also shows how to override several other parameters for the driver. See [“Custom Driver Parameters” on page 55](#) for more information about these parameters.

Using Named Passwords

The Identity Manager engine provided with Identity Manager 2 or later added a new way of securing the passwords you need to use in your driver policies. The sample driver configuration shows an example.

One use for this feature would be to store a password for each of your Notes Certifiers. For example, if you had certifiers for Human Resources, Engineering, and Marketing, you could use Named Passwords to securely store the password for each respective Certifier ID file in your driver parameters. In the driver configuration, you would click the **Edit XML** button and specify driver parameters something like this:

```
<cert-id-password display-name="Certifier Password" is-sensitive="true"
type="password-ref">HR</cert-id-password>
```

```
<cert-id-password display-name="Certifier Password" is-sensitive="true"
type="password-ref">Engineering</cert-id-password>
```

```
<cert-id-password display-name="Certifier Password" is-sensitive="true"
type="password-ref">Marketing</cert-id-password>
```

When you return to the graphical interface for the driver parameters, each of these passwords has prompts to enter the password and confirm the password. These passwords are encrypted and stored with the driver configuration. You can reference these passwords by name in your driver policies.

See the sample configuration for using Named Passwords in [“Example Files” on page 91](#). You can also find more information in the NotesCertifierSelectionSampleSS.xsl sample style sheet and in the NotesConfig21.xml file in the same section.

Using Driver Parameters

To change driver parameters, edit the Driver Parameters page as follows:

- 1 In iManager, click **Identity Manager > Identity Manager Overview**.
- 2 Select the driver set containing the driver.
- 3 Click the driver icon to display the Driver Overview page.
- 4 Click the driver icon in the driver Overview page to display the Modify Object page.

- 5 Click **Driver Configuration**.
- 6 Use the information in the sections that follow to upgrade driver parameters.
 - ♦ “Driver Options” on page 41
 - ♦ “Subscriber Options” on page 44
 - ♦ “Publisher Options” on page 51

Driver Options

The first column of the following table contains the parameter name followed by its common description. The parameters are alphabetized according to the XML parameter name.

The third column of the following table contains XML text that you can paste into the Driver Parameters XML editor. The XML text represents exactly what is necessary to display the parameters. You can also place the information that you see under the Description heading within the `<description> </description>` tags.

Table 5-1 Driver Parameters

Parameter Name and Common Description	Description	XML to Define Driver Parameters
allow-document-locking Allow Document Locking	Enables Notes database documents to be locked by the Notes Driver shim if they are being modified. The Notes database has the Allow document locking check box selected.	<pre><definition display-name="Allow Document Locking?" name="allow-document-locking" type="boolean"> <description> </description> <value>true</value> </definition></pre>
cert-id-file Default Certifier ID file	The default Notes Certifier ID file that is used to register user objects in the Notes Address Book. The full path of the file should be represented with respect to the operating system hosting Domino.	<pre><definition display-name="Default Certifier ID File" name="cert-id-file" type="string"> <description> </description> <value>c:\lotus654\domino\data\ids\people\ndriver.id</value> </definition></pre>

Parameter Name and Common Description	Description	XML to Define Driver Parameters
cert-id-password Default Certifier ID password	<p>The default Notes Certifier ID file password that is used to register user objects in the Notes Address Book.</p> <p>When it is using the type="password-ref" attribute of this parameter, the password is encrypted and securely stored with the Driver Configuration. When it is securely stored in this way, the password can then be referenced by the Identity Manager engine or a driver by using the key name specified. (In this example, defaultCertPwd.)</p>	<pre><definition display-name="Default Certifier Password" is-sensitive="true" name="cert-id-password" type="password-ref"> <description> </description> <value>defaultCertPwd</value> </definition></pre>
directory-file Directory File or Input Database	<p>The filename of the database to be synchronized with the Identity Vault. Specify this item without full path information.</p>	<pre><definition display-name="Directory File" name="directory-file" type="string"> <description> </description> <value>names.nsf</value> </definition></pre>
is-directory Notes Address Book	<p>Specify True if the input database (directory file) is a Notes Address book; otherwise, specify False.</p>	<pre><definition display-name="Notes Address Book?" name="is-directory" type="boolean"> <description> </description> <value>true</value> </definition></pre>
janitor-cleanup-interval Janitor Cleanup Interval	<p>Janitor cleanup checks for and releases resources that might have been orphaned by unfinished query-ex sequences. This interval determines how often to perform this service.</p>	<pre><definition display-name="Janitor Cleanup Interval (in minutes)" name="janitor-cleanup-interval" type="integer"> <description> </description> <value>30</value> </definition></pre>

Parameter Name and Common Description	Description	XML to Define Driver Parameters
notes-domain Notes Domain Name	The name of the Notes domain the driver is running against. It might be different from the Notes Organization name, and therefore can't be derived from the server name.	<pre><definition display-name="Notes Domain Name" name="notes-domain" type="string"> <description> </description> <value>PROV01</value> </definition></pre>
server-id-file Server ID File (deprecated)	The Notes Server ID file associated with the Notes Server this driver authenticates to (This is optional). The full path of the file should be represented with respect to the operating system hosting Domino. This ID file does not need to be the server ID file. It can actually be an ID file that has no password (and it does not need to have any access anywhere).	<pre><definition display-name="Domino Server ID File" name="server-id-file" type="string"> <description> </description> <value>c:\lotus654\domino\data\server.id</value> </definition></pre>
update-file Update File or ndsrep polling cache	<p>The filename of the database used to cache database changes that need to be published to the Identity Vault. The default is ndsrep.nsf. Specify this item without full path information.</p> <p>The Driver's Domino add-in ndsrep process creates this database. Within this database, filtered updates are cached before being consumed by the Notes Driver's publisher.</p>	<pre><definition display-name="Update File" name="update-file" type="string"> <description> </description> <value>ndsrep.nsf</value> </definition></pre>
user-id-file Notes User ID file	The Notes User ID file associated with the Notes User this driver represents (this is required). The full path of the file should be represented with respect to the operating system hosting Domino. The password associated with this user ID file is input in Driver Configuration > Authentication > Specify the application password .	<pre><definition display-name="Notes Driver User ID File" name="user-id-file" type="string"> <description> </description> <value>c:\lotus654\domino\data\ids\people\ndriver.id</value> </definition></pre>

Subscriber Options

The first column of the following table contains the parameter name followed by its common description. The parameters are alphabetized according to the XML parameter name.

The third column of the following table contains XML text that you can paste into the Driver Parameters XML Editor. The XML text represents exactly what is necessary to display the parameters. You can also place the information that you see under the Description heading within the `<description> </description>` parameters.

NOTE: Some parameters have values that are listed in second (Description) column. These parameters contain values such as Success, Warning, Error, Retry, or Fatal. The correct XML text for such parameters can be found in the [drvparamdefs.xml file \(../samples/drvparamdefs.xml\)](#).

Table 5-2 Subscriber Channel Parameters

Parameter Name and Common Description	Description	XML to Define Driver Parameters
allow-adminp-support Allow Domino AdminP Support	Specifies that AdminP features can be used. If you want to use the AdminP features, you must add this parameter and set it to True. If the parameter does not exist in the driver parameters, the default setting is False. This parameter can be overridden on a command-by-command basis by using the Allow AdminP Support attribute described in Table 5-4 on page 56 .	<pre><definition display-name="Allow Domino AdminP Support" name="allow-adminp-support" type="boolean"> <description> </description> <value>true</value> </definition></pre>
allow-http-password-set Allow Notes Web (HTTP) Password Set	Set the parameter to True to allow the Notes driver to set or to change the Web (HTTP) password attribute on user objects. Set the parameter to False to disallow the Notes driver from setting or changing the web (HTTP) password attribute on user objects. The default setting is True.	<pre><definition display-name="Allow Notes Web (HTTP) Password Set" name="allow-http-password-set" type="boolean"> <description> </description> <value>true</value> </definition></pre>

Parameter Name and Common Description	Description	XML to Define Driver Parameters
allow-userid-password-set Allow user.id Password Set	Specifies if Notes driver shim should modify the password of user.id files. This parameter can be overridden by <allow-userid-password-set> as an attribute to the <modify-password> element.	<pre><definition display-name="Allow user.id password set" name="allow-userid-password-set" type="boolean"> <description> </description> <value>true</value> </definition></pre>
cert-users Certify/Register Users	<p>This parameter indicates the default behavior for the driver regarding Notes user account creation. Yes indicates the driver attempts to register users in the Notes Address book by certifying them and creating an ID file for each user when add events are received.</p> <p>You can override this default setting by using the XML certify-user attribute.</p>	<pre><definition display-name="Certify (register) Notes Users" name="cert-users" type="boolean"> <description> </description> <value>true</value> </definition></pre>
create-mail Create Mail DB	<p>This parameter indicates the default behavior for the driver regarding e-mail account creation. True indicates the driver by default attempts to create a Notes Mail database (mailfile) when adding a new user.</p> <p>You can override this default setting by using the XML create-mail attribute.</p>	<pre><definition display-name="Create User E-Mail Box" name="create-mail" tmpId="238" type="boolean"> <description> </description> <value>true</value> </definition></pre>
db-creation-max-collisions Number of File Creation Collision Retry Attempts	Specify a positive integer value indicating the highest number to append to a filename when attempting to resolve filename collisions. If Notes driver shim cannot create a mailfile or a mailfile replica because of a filename collision, the Notes driver shim appends an integer text value to the end of the attempted filename and tries again to create the file. Thus, if the mailfile JohnDoe.nsf already exists, the Notes driver shim attempts to create JohnDoe1.nsf. If this value is 0, this file creation after filename collision feature is not invoked.	<pre><definition display-name="Number of File Creation Collision Retry Attempts" name="db-creation-max-collisions" type="integer"> <value>5</value> </definition></pre>

Parameter Name and Common Description	Description	XML to Define Driver Parameters
default-http-password Default HTTP Password	The default Notes Web (HTTP) password set for newly created Notes users. You can override this default setting by using the XML <code>user-pwd</code> attribute tag.	<pre><definition display-name="Default HTTP Password" name="default-http-password" type="string"> <description> </description> <value>notes</value> </definition></pre>
default-password Default Notes Password	The default Notes User ID password for newly created Notes users. You can override this default setting by using the XML <code>user-pwd</code> attribute.	<pre><definition display-name="Default Notes Password" name="default-password" type="string"> <description> </description> <value>notes</value> </definition></pre>
Delete User: Mark user as inactive	Set this flag to True to mark the user as inactive in the ID Vault database.	<pre><definition display-name="Delete User:Mark user as inactive" id="176" name="inactive-IDVault-delete-flag" type="boolean"> <description> </description> <value>>true</value> </definition></pre>
delete-user-from-IDVault-support	Domino version 8.5 supports ID Vault to store ID files in a separate database.	<pre><definition display-name="delete-user-from-IDVault-support" id="174" name="delete-user-from-IDVault-support" type="boolean"> <description> </description> <subordinates active-value="true"> </subordinates> <value>>false</value> </definition></pre>

Parameter Name and Common Description	Description	XML to Define Driver Parameters
expiration-term Expiration Term	The default expiration term (specified in years) for newly created Notes User ID files. You can override this default setting by using the XML attribute <code>expire-term</code> .	<pre><definition display-name="Default User ID File/Registration Expiration Term (in years)" name="expiration-term" type="integer"> <description> </description> <value>2</value> </definition></pre>
internet-mail-domain Internet Mail Domain Name	Obsolete in version 2.0.	<pre><definition display-name="Internet Mail Domain" name="internet-mail-domain" type="string"> <description> </description> <value></value> </definition></pre>
ID Vault Database File Name	Specify the name of the ID Vault database file.	<pre><definition display-name="ID Vault database file name" id="175" name="IDVault-database" type="string"> <value xml:space="preserve"> domino_vault_duplicate.nsf</value> </definition></pre>

Parameter Name and Common Description	Description	XML to Define Driver Parameters
<p>mailfile-acl-level</p> <p>Add User E-Mail ACL Level</p>	<p>The default ACL setting for the newly created mail file of newly created user objects. Valid values are NOACCESS, DEPOSITOR, READER, AUTHOR, EDITOR, DESIGNER, and MANAGER. When no ACL setting is specified, the setting defaults to MANAGER.</p> <p>You can override this default setting by using the XML attribute mailfile-acl-level.</p>	<pre><definition display-name="Add User E-Mail: E-Mail Database ACL Setting" name="mailfile-acl-level" type="enum"> <description> </description> <value>default</value> </definition></pre> <p>See the Note at the top of Subscriber Options (page 44), then use the values under the Description heading for this parameter.</p>
<p>mailfile-path</p> <p>User Mail File Storage Location</p>	<p>A mail storage path relative to the Domino data storage location where mail files are stored if created by the driver. For example, if the parameter is set to "mail," then new mail files created by the driver on the Domino server (running on Linux) are stored in the /local/notesdata/mail folder.</p>	<pre><definition display-name="User Mail File Storage Location" name="mailfile-path" type="string"> <description> </description> <value>mail</value> </definition></pre>
<p>mailfile-template</p> <p>E-Mail File Template</p>	<p>The .ntf database template to be used when creating a new mail database when the driver creates a user e-mail account. This template must be accessible to the Domino server in the Domino data folder.</p>	<pre><definition display-name="Mail File Template" name="mailfile-template" type="string"> <description> </description> <value>mail654.ntf</value> </definition></pre>
<p>mail-server</p> <p>Domino Mail Server Name</p>	<p>The DN of the Domino server that holds the mail files.</p> <p>You can override this default setting by using the XML <MailServer> element as a child of the add event element, or the mail-server XML attribute tag.</p>	<pre><definition display-name="Domino Mail Server Name" name="mail-server" type="string"> <description> </description> <value>CN=blackcap/O=novell</value> </definition></pre>

Parameter Name and Common Description	Description	XML to Define Driver Parameters
<p>minimum-pwd-len</p> <p>Notes Password Strength</p>	<p>The default minimum password strength (0-16) for newly created Notes User ID files.</p> <p>You can override this default setting by using the XML attribute tag <code>minimum-pwd-len</code>.</p>	<pre><definition display-name="Notes Password Strength (0 - 16)" name="minimum-pwd-len" type="integer"> <description> </description> <value>2</value> </definition></pre>
<p>north-american-flag</p> <p>Is Domino Server North American?</p>	<p>North American Server User ID file (Certifier) property. Set to True only if the Domino server is in North America.</p> <p>According to Domino registration requirements, this attribute is required for user ID file creation.</p>	<pre><definition display-name="Is Domino Server North American?" name="north-american-flag" type="boolean"> <description> </description> <value>true</value> </definition></pre>
<p>notes-doc-lock-fail-action</p> <p>Notes Document Locking Failure Action</p>	<p>Specify the action (document return code) that the Notes Driver returns to the Identity Manager engine if the Notes Driver fails to acquire a document lock. The value choices are Retry (default), Warning, Error, Fatal, and Success.</p> <p>This parameter is overwritten by <code>retry-status-return</code> and is only valid if the <code>allow-document-locking</code> is set to True.</p>	<pre><definition display-name="Document Lock Failure Action" name="notes-doc-lock-fail-action" type="enum"> <value>retry</value> </definition></pre> <p>See the Note at the top of Subscriber Options (page 44).</p>
<p>notes-save-fail-action</p> <p>Notes Document Save Failure Return Code</p>	<p>Specify the action (document return code) the Notes Driver returns to the Identity Manager engine if the Notes Driver fails to properly save a document in the synchronized Notes database. If the parameter does not exist in the driver parameters, the default value is Retry.</p> <p>Possible values are Success, Warning, Error, Retry, or Fatal.</p> <p>You can use this parameter when troubleshooting and is overwritten by the <code>retry-status-return</code> attribute.</p>	<pre><definition display-name="Notes Document Save Failure Return Code" name="notes-save-fail-action" type="enum"> <description> </description> <value>warning</value> </definition></pre> <p>See the Note at the top of Subscriber Options (page 44).</p>

Parameter Name and Common Description	Description	XML to Define Driver Parameters
notes-v1-schema-format Use NotesDriver v1 Schema Format	Specify whether the NotesDriver should publish Notes schema documents in its original v1 format.	<pre><definition display-name="Use NotesDriver v1 schema format" name="notes-v1-schema-format" type="boolean"> <description> </description> <value>>true</value> </definition></pre>
retry-status-return Failed Command Reply Status	<p>Specify the action (document return code) the Notes Driver returns to the Identity Manager engine if the Notes Driver cannot process a command due to connectivity or application processing failure. If the parameter does not exist in the driver parameters, the default setting is Retry.</p> <p>Possible values are Success, Warning, Error, Retry, or Fatal.</p> <p>This parameter can be used when troubleshooting critical situations, and takes precedence over notes-save-fail action and notes-doc-lock-fail-action.</p>	<pre><definition display-name="Retry Status Return Code" name="retry-status-return" type="enum"> <enum-choice display-name="Retry"> retry <enum-choice><description> </description> <value>retry</value> </definition></pre> <p>See the Note at the top of Subscriber Options (page 44).</p>
store-id-ab-flag Store User ID in Address Book	<p>This flag indicates the default behavior for the driver for attaching user ID files to their respective user objects in the Notes Address Book at registration time.</p> <p>Setting the flag to True causes registered user objects in the Notes Address Book to be created with an attached user ID file.</p> <p>Setting the flag to False causes registered user objects in the Notes Address Book to be created without an attached user ID file.</p> <p>You can override this default setting by using the XML attribute store-useridfile-in-ab.</p>	<pre><definition display-name="Store User ID File in Address Book" name="store-id-ab-flag" type="boolean"> <description> </description> <value>true</value> </definition></pre>

Parameter Name and Common Description	Description	XML to Define Driver Parameters
update-ab-flag Add Registered Users To Address Book	This parameter indicates the default behavior for the driver for placing registered user objects in the Notes Address Book. Setting the flag to True causes registered users to be placed in the address book. Setting the flag to False causes users to be registered (meaning that a Certifier ID file is created for the user) without the user object being placed into the Notes Address Book. You can override this default setting by using the XML update-addressbook attribute.	<pre><definition display-name="Add Registered Users to Address Book" name="update-ab-flag" type="boolean"> <description> </description> <value>true</value> </definition></pre>

Publisher Options

The first column of the following table contains the parameter name followed by its common description. The parameters are alphabetized according to the XML parameter name.

The third column of the following table contains XML text that you can paste into the Driver Parameters XML Editor. The XML text represents exactly what is necessary to display the parameters. You can also place the information that you see under the Description heading within the `<description> </description>` parameters.

NOTE: Some parameters have values that are listed in second (Description) column. These parameters contain values such as Success, Warning, Error, Retry, or Fatal. The correct XML text for such parameters can be found in the [drvparamdefs.xml](#) file (`../samples/drvparamdefs.xml`).

Table 5-3 Publisher Channel Parameters

Parameter Name and Common Description	Description	XML to Define Driver Parameters
check-attrs-flag Check Attributes	The ndsrep check and publish attributes parameter. Set it to True if only modified attributes within the Publisher filter should be sent to the Identity Vault via the Publisher channel when a Notes object is modified. Set it to False if all sync attributes specified within the Publisher filter should be sent to the Identity Vault via the Publisher channel when a Notes object is modified. The default value is True.	<pre><definition display-name="Check Attributes?" name="check-attrs-flag" type="boolean"> <description> </description> <value>true</value> </definition></pre>

Parameter Name and Common Description	Description	XML to Define Driver Parameters
config-db-name NDSREP Configuration Database	<p>The ndsrep configuration database filename created and maintained by the driver. This parameter controls which .nsf database the driver shim uses to write its publication options.</p> <p>The full path of the filename should be represented with respect to the operating system hosting Domino. When using this parameter, ndsrep needs to be loaded with the -f filename parameter.</p> <p>ndsrep load example:</p> <pre>load ndsrep NotesDriver2 -f / home/notes/mycfg.nsf</pre> <p>If this parameter is not present, by default the Configuration database filename is set to dsrepcfg.nsf and is normally located in the Domino data folder.</p> <p>If the name of your driver includes spaces, then you must put quotes around the name.</p>	<pre><definition display- name="NDSREP Configuration database" name="config-db-name" type="string"> <description> </ description> <value>mycfg.nsf</ value> </definition></pre>
dn-format DN Format	<p>The Distinguished Name format used by ndsrep. Valid values are NOTES_TYPED, NOTES, SLASH_TYPED, SLASH, LDAP, LDAP_TYPED, DOT, and DOT_TYPED. The default is SLASH.</p>	<pre><definition display- name="DN FORMAT" name="dn-format" type="enum"> <description> </ description> <value>SLASH</value> </ definition></pre>

Parameter Name and Common Description	Description	XML to Define Driver Parameters
instance-id NDSREP Configuration Instance	<p>The ndsrep configuration instance name created and maintained by the driver within the ndsrep configuration database. This parameter controls which database note the driver shim uses to read and write its publication options within the ndsrep configuration database. When it uses this parameter, ndsrep utilizes the settings of this configuration instance when loaded with this instance name as a parameter.</p> <p>If this parameter is not present, by default the configuration instance is set to the name of the driver (the driver RDN in Identity Vault.)</p> <p>ndsrep load example:</p> <pre>load ndsrep NotesDriver2</pre> <p>If the name of your driver includes spaces, then you must put quotes around the name.</p>	<pre><definition display-name="NDSREP Configuration Instance" name="instance-id" type="string"> <description> </description> <value>NotesDriver2</value> </definition></pre>
loop-detect-flag Enable Loop Back Detection	<p>Loopback detection parameter. Set it to True to enable loopback detection. Set it to False to disable loopback detection.</p>	<pre><definition display-name="Enable Loop Back Detection" name="loop-detect-flag" type="boolean"> <description> </description> <value>>true</value> </definition></pre>
ndsrep-console-trace-level NDSREP Console Trace Level	<p>Possible values are SILENT, NORMAL, VERBOSE, or DEBUG.</p> <p>If this parameter is not present, the default setting is NORMAL.</p>	<pre><definition display-name="NDSREP Domino Console Trace Level" name="ndsrep-console-trace-level" type="enum"> <description> </description> <value>NORMAL</value> </definition></pre> <p>See the Note at the top of Publisher Options (page 51), then use the values under the Description heading for this parameter.</p>

Parameter Name and Common Description	Description	XML to Define Driver Parameters
<p>schedule-units</p> <p>NDSREP Schedule Units</p>	<p>The ndsrep polling interval unit. Valid values are SECONDS, MINUTES, HOURS, DAYS, and YEARS. The default value is SECONDS.</p>	<pre><definition display-name="NDSREP Polling Units" name="schedule-units" type="enum"> <description> </description> <value>SECONDS</value> </definition></pre> <p>See the Note at the top of Publisher Options (page 51), then use the values under the Description heading for this parameter.</p>
<p>schedule-value</p> <p>NDSREP Schedule Value</p>	<p>The ndsrep polling interval unit value. This value is utilized in conjunction with the schedule-units configuration parameter.</p>	<pre><definition display-name="NDSREP Polling interval" name="schedule-value" type="integer"> <description> </description> <value>30</value> </definition></pre>
<p>polling-interval</p> <p>Polling Interval</p>	<p>Notes Driver Shim publisher polling interval, specified in seconds.</p>	<pre><definition display-name="Polling Interval (in seconds)" name="polling-interval" type="integer"> <description> </description> <value>30</value> </definition></pre>
<p>pub-heartbeat-interval</p> <p>Publication Heartbeat Interval</p>	<p>Publication Heartbeat Interval specified in minutes. If no documents are sent on the Publisher channel for this specified interval (duration of time), a heartbeat document is sent by the driver. A value of 0 indicates that no heartbeat documents are to be sent.</p> <p>If this parameter is not present, by default the publication heartbeat interval is 0.</p>	<pre><definition display-name="Heartbeat Interval (in minutes)" name="pub-heartbeat-interval" type="integer"> <description> </description> <value>0</value> </definition></pre>

Parameter Name and Common Description	Description	XML to Define Driver Parameters
pub-heartbeat-interval-seconds Publication Heartbeat Interval (in seconds)	Publication Heartbeat Interval specified in seconds. This parameter can be used instead of pub-heartbeat-interval to provide finer interval size granularity. If no documents are sent on the Publisher channel for this specified interval (duration of time), then a heartbeat document is sent by the driver. A value of 0 indicates that no heartbeat documents are to be sent. If this parameter is not present, by default the publication heartbeat interval is 0.	<pre><definition display-name="Heartbeat Interval (in seconds)" name="pub-heartbeat-interval-seconds" type="integer"> <description> </description> <value>0</value> </definition></pre>
write-timestamps-flag Write Time Stamps?	Specifies whether ndsrep writes a special driver time stamp on synchronized Notes parameter. Set it to True to have ndsrep write a driver-specific time stamp on all Notes objects that are synchronized. This special driver time stamp is used to determine Notes object attribute updates more accurately. Set it to False to have ndsrep determine Notes object attribute updates based on existing Notes object time stamps. The default value is True.	<pre><definition display-name="Write Time Stamps?" name="write-timestamps-flag" type="boolean"> <description> </description> <value>true</value> </definition></pre>

Custom Driver Parameters

You can override many of the driver configuration parameters by using custom driver parameters in policies.

An example of two overrides is shown in [“Automatically Determining Which Certifier to Use” on page 39](#). In the `Cert.xsl` sample style sheet, the Certifier ID and Certifier password are passed as attributes of the `add` XML element. The driver finds those parameters and uses the passed values instead of the default values from the driver parameters. The parameters apply as indicated in the **Valid Use** column of [Table 5-4 on page 56](#).

If an attribute overriding a default configuration parameter is present, it is applied to the note with respect to the event type. Because these parameters often map to items in Lotus Notes, these overrides are passed as the attributes of the event element, or `<add-attr>` children of the event element in the XML document.

Another example is in the sample driver configuration, in the style sheet named `AddAccountNotesOptions.xml`. It utilizes global configuration values (GCVs) specified in `NotesConfig21.xml` to determine which setting to apply.

For items that use **Yes** or **No** values, **True** or **False** values can also be used.

The Notes Driver can add or modify ACL entries on the ACL record of a Lotus Notes database (.nsf) that is being synchronized (Subscriber channel only). Likewise, the ACL of a new mail file that the Notes driver shim creates for a user can be modified with specific settings at creation time. These parameters are also included in [Table 5-5 on page 74](#).

The Notes Driver can apply database replication settings and replication entry settings. The driver can create a database replica, as well as request to perform replication, which can also create a mailfile replica when a mailfile is initially created.

This enhancement also allows for modifying replication settings of the existing database that is being synchronized, to perform a replication request on the synchronized database, and to create a new replica on an accessible Domino server.

- ◆ [“ACL Custom Parameters” on page 74](#)
- ◆ [“mailfile Custom Parameters” on page 77](#)
- ◆ [“Rep Custom Parameters” on page 88](#)

Table 5-4 Custom Parameters That Override Driver, Subscriber, and Publisher Parameters

Parameter Name and Common Description	Description	Valid Use
adminp-server Administration Process Server	Specifies the Domino server with which the driver establishes an administration process session or sends a console command. By default, the driver connects to the local server specified in the driver parameters. Example: adminp-server="myserver1/acme".	As an attribute to an add, modify, move, delete, or domino-console-command command element. When the parameter is used in a delete operation, it only applies to removal of ID Vault entry. String
adminp-web-user- rename AdminP Web User Rename	Specifies whether the Notes Driver Shim attempts to issue a Notes AdminP request to rename a Notes Web User. By default, the Notes driver shim uses its own detection mechanism and logic to determine if the AdminP rename operation request is for a Notes Web User (Initiate Web User Rename in Domino Directory) or a standard Notes person (Initiate Rename in Domino Directory). This custom parameter allows the modify command to specify if the AdminP rename request should be for a Notes Web user or not.	As an XML attribute to the modify element (of a person object). Boolean: true false

Parameter Name and Common Description	Description	Valid Use
<p>allow-adminp-support</p> <p>Allow AdminP Support</p>	<p>Specifies whether the command received by the Notes driver shim should allow issuing AdminP requests if possible. The attribute can be True or False. The default is False if it is not set with the allow-adminp-support driver parameter in the subscriber-options section. This attribute can be used to override Allow Domino AdminP Support in “Subscriber Options” on page 44, on a command-by-command basis.</p> <p>Example: allow-adminp-support="true".</p> <p>NOTE: If a Notes person is renamed in the Identity Vault when allow-adminp-support is set to True, the renaming attributes are added to the AdminP request queue in the Domino server. When this parameter is set to False, no request is added to the AdminP queue and the Notes person is directly renamed in the names.nsf file.</p>	<p>As an attribute to an add, modify, move, rename, or delete command element.</p> <p>Boolean: true false</p>
<p>allow-http-password-set</p> <p>Allow HTTP Password Set</p>	<p>Specifies if the modify-password command should attempt to modify the HTTPPassword for a given user. This parameter overrides the default driver parameter value allow-http-password-set, which you can specify in the driver's Subscriber Options parameter section.</p>	<p>As an XML attribute of a modify-password element.</p> <p>Boolean: true false</p>
<p>allow-userid-password-set</p> <p>Allow user.id Password Set</p>	<p>Specifies if the modify-password command should attempt to modify the password of a given user.id file. This parameter overrides the default driver parameter value allow-userid-password-set, which you can specify in the driver's Subscriber Options parameter section.</p>	<p>As an XML attribute of a modify-password element.</p> <p>Boolean: true false</p>
<p>AltFullNameLanguage</p> <p>Language of Alternate Full Name</p>	<p>This element specifies the language used for the Alternate Full Name when registering a new user. Like other user attributes, this can be synchronized by using an attribute in Identity Vault or inserted in a style sheet. See the Lotus Notes documentation for information on setting AltFullNameLanguage for a user.</p>	<p>As an add-attr child element of an add event.</p> <p>String</p>

Parameter Name and Common Description	Description	Valid Use
AltFullName Alternate Full Name	This element specifies the Alternate Full Name attribute in Notes when registering a new user. Like other user attributes, this can be synchronized by using an attribute in Identity Vault or inserted in a style sheet. See the Lotus Notes documentation for information on setting AltFullName for a user.	As an add-attr child element of an add event. String
alt-org-unit Alternate Organization Unit	Specifies the alternate Organization Unit when registering a new user in Notes.	As an attribute to an add command element. String
alt-org-unit-lang Alternate Organization Unit Language	Specifies the alternate Organization Unit language when registering a new user in Notes.	As an attribute to an add command element. String
cert-expire-date Certification Expiration Date	Specifies the date when a user Certifier expires. This attribute can be applied to override the default expiration term specified in the driver parameters. It is used by the Notes Driver shim when processing events that result in AdminP requests that cause the recertification of the user, such as move, rename, or recertify, or on an add event when creating new Notes users. The date format should be specified in text, using the appropriate format of the locale of the computer hosting the Notes Driver shim. For example, in English, cert-expire-date="1 July 2010". An alternate to this attribute is expire-term.	As an attribute to an add, modify, or move command element. String
cert-id Certifier ID File	This XML attribute specifies the Notes Certifier ID file that is used to register this user object in the Notes Address Book. The full path of the file should be represented with respect to the operating system hosting Domino. Overrides the default Notes Certifier ID file parameter cert-id-file in the driver configuration.	As an attribute to an add command element String
cert-id-type User ID file certifier type	This XML attribute specifies the User ID file certifier type when user ID files are created at user registration time. Valid values are ID_FLAT, ID_HIERARCHICAL, and ID_CERTIFIER. The absence of this XML attribute sets the default certifier type of ID_HIERARCHICAL.	As an attribute to an add command element. String

Parameter Name and Common Description	Description	Valid Use
cert-pwd Certifier Password	This XML attribute specifies the Notes Certifier ID password to be used with the Certifier ID file. The password value is passed in clear text. The Notes Certifier ID file and password are used to register user objects in the Notes Address Book. Overrides the default Notes Certifier ID file cert-id-password parameter in the driver configuration. Alternates are named-cert-pwd and drv-param-cert-pwd.	As an attribute to an add command element. String
certificate-authority-org Certificate Authority Organization	This custom parameter is deprecated. The value certificate-authority-org specifies a certificate name, and is used in conjunction with custom parameter use-certificate-authority="true". If Domino CA services are functional, this parameter can be used instead of cert-id (or its alternate: drv-param-cert-id) and cert-pwd (or its alternates: drv-param-cert-pwd or named-cert-pwd) XML attributes. Example: certificate-authority-org="/certwest/west". This custom parameter has an alternate of certifier-name.	As an attribute to an add, modify command element. String: Notes name of the Notes Certifier

Parameter Name and Common Description	Description	Valid Use
<p>certifier-name Certifier Name</p>	<p>For add or modify, the parameter specifies a certificate name. Use in conjunction with custom parameter use-certificate-authority="true". If Domino CA services are functional, you can use this parameter instead of cert-id (or its alternate: drv-param-cert-id) and cert-pwd (or its alternates: drv-param-cert-pwd or named-cert-pwd) XML attributes.</p> <p>Example: certifier-name="/certwest/west". This custom parameter has a deprecated alternate of certificate-authority-org.</p> <p>For move, this specifies the certifier name required to move a user in Notes from an old certifier to a new certifier. The value is the name of the new certifier where the user is moving to. Use this attribute in conjunction with old-cert-id or one of its alternates, old-cert-pwd or one of its alternates, cert-id or one of its alternates, and cert-pwd or one of its alternates. The cert-id specified should belong to the certifier-name.</p> <p>Example: certifier-name="/mktg/acme".</p>	<p>As an attribute to an add, modify, or move command element.</p> <p>String: the Notes name of the Notes Certifier</p>
<p>certify-user Certify User Flag</p>	<p>Applying this XML attribute determines the behavior for the driver regarding Notes user account creation. Its value can be Yes or No. Yes indicates the driver will register this user in the Notes Address book by certifying the user (meaning it creates an ID file for the user).</p> <p>Overrides the default Certify Users flag cert-users in the driver configuration.</p>	<p>As an attribute to an add command element.</p> <p>String</p>
<p>comparison-operator Comparison Operator</p>	<p>Specifies the method of comparison for the value during the Notes database search in order to satisfy a query command.</p>	<p>Within an XDS query document, as an attribute to the value element.</p> <p>String - '=', '<', '>', '<=', '>=', '!=', '!'.</p>

Parameter Name and Common Description	Description	Valid Use
<p>compute-with-form</p> <p>Compute With Form</p>	<p>Specifies whether Notes driver shim will attempt to <code>computeWithForm()</code> prior to saving a newly created or modified Notes Document. When passing a <code>compute-with-form="true"</code> XML attribute on a XDS driver command, the Notes driver shim attempts to execute the Notes document's <code>computeWithForm()</code> method, prior to saving any changes to a modified (or newly created) Notes document.</p> <p>The <code>computeWithForm()</code> method should appropriately execute any database designs that are associated with computing fields defined by that particular form that is defined within the synchronized Notes database.</p>	<p>As an attribute to an <code>add</code>, or <code>modify</code> command element.</p> <p>Boolean: true false</p> <p>The default is False</p>
<p>create-mail</p> <p>Create Mail File Flag</p>	<p>This XML attribute indicates whether the driver needs to create an e-mail account for this user. Its value can be Yes or No. Yes indicates the driver will attempt to create a Notes Mail database when adding (creating) this new user. Overrides the default Create Mail File flag <code>create-mail</code> in the driver configuration.</p>	<p>As an attribute to an <code>add</code> command element.</p> <p>Boolean: true false</p>
<p>delete-windows-group</p> <p>Delete Windows Group</p>	<p>Specifies whether synchronized Windows groups should be deleted from Windows or not. The value is True or False. Domino has its own capability of synchronizing users and groups with Windows systems. When the Notes Driver shim utilizes AdminP to delete a group, the request can also indicate that this deletion should be synchronized with Windows. By default, this attribute is set to False.</p> <p>Example: <code>delete-windows-group="true"</code>.</p>	<p>As an attribute to a <code>delete class="group"</code> command element.</p> <p>Boolean: true false</p>

Parameter Name and Common Description	Description	Valid Use
delete-windows-user Delete Windows User	<p>Specifies whether synchronized Windows users should be deleted from Windows or not. The value is True or False. Domino has its own capability of synchronizing users and groups with Windows systems. When the Notes Driver shim utilizes AdminP to delete a user, the request can also indicate that this deletion should be synchronized with Windows. By default, this attribute is set to False.</p> <p>Example: delete-windows-user="true".</p>	<p>As an attribute to a delete class="user" command element.</p> <p>Boolean: true false</p>
deny-access-group-id Deny Access Group ID	<p>Specifies the Notes deny access group UNID for a delete event. When the Notes Driver shim utilizes AdminP to delete users from Notes, it has the capability to attach a deny access group name to that AdminP delete user request, so the deleted user's name is inserted as a member of the specified deny access group. An alternate attribute is deny-access-group-name.</p> <p>Example: deny-access-group-id="7EFB951A3574521F87256E540001F140".</p>	<p>As an attribute to a delete command element.</p> <p>String</p>
deny-access-group-name Deny Access Group Name	<p>Specifies the Notes deny access group name for a delete event. When the Notes Driver shim utilizes AdminP to delete users from Notes, it has the capability to attach a deny access group name to that AdminP delete user request, so the deleted user's name is inserted as a member of the specified deny access group. An alternate attribute is deny-access-group-id.</p> <p>Example: deny-access-group-name="Deny Access".</p>	<p>As an attribute to a delete command element.</p> <p>String</p>

Parameter Name and Common Description	Description	Valid Use
drv-param-cert-id Certifier ID File Parameter Reference	<p>This XML attribute can be used instead of the Certifier ID file <code>cert-id</code> XML attribute. This attribute specifies a driver parameter that holds the Notes Certifier ID file that is used to register this user object in the Notes Address Book. The driver parameter XML attribute can have any name, but its value needs to indicate the full path of the Certifier ID file with respect to the operating system hosting Domino. Overrides the default Notes Certifier ID file parameter <code>cert-id-file</code> in the driver configuration.</p>	<p>As an attribute to an <code>add</code> command element</p> <p>String</p>
drv-param-cert-pwd Certifier Password Parameter Reference	<p>This attribute can be used instead of the Certifier Password <code>cert-pwd</code> XML attribute. This attribute specifies a driver parameter that holds the Notes Certifier ID password to be used with the Certifier ID file that is used to register this user object in the Notes Address Book. The driver parameter XML attribute can have any name, but its value indicates the password of the Certifier ID file. The referenced driver parameter can be a clear-text password or an encrypted named password. The Notes Certifier ID file and password are used to register user objects in the Notes Address Book. Overrides the default Notes Certifier ID file password parameter <code>cert-id-password</code> in the driver configuration. Alternates are <code>cert-pwd</code> and <code>named-cert-pwd</code>.</p>	<p>As an attribute to an <code>add</code> command element.</p> <p>String</p>
drv-param-old-cert-id Driver Parameter Old Certifier ID	<p>Specifies the driver parameter holding the old Certifier ID file name required to move a user in Notes from an old certifier to a new certifier. The value is the driver parameter XML attribute. An alternate to this attribute is <code>old-cert-id</code>. This attribute should be used in conjunction with <code>certifier-name</code>, <code>old-cert-pwd</code> or one of its alternates, <code>cert-id</code> or its alternate, and <code>cert-pwd</code> or one of its alternates.</p> <p>Example: <code>drv-param-old-cert-id="mktg-cert-id-file"</code>.</p>	<p>As an attribute to a <code>move</code> command element.</p> <p>String</p>

Parameter Name and Common Description	Description	Valid Use
drv-param-old-cert-pwd Driver Parameter Old Certifier Password	<p>Specifies the driver parameter holding the password for the old Certifier ID file required to move a user in Notes from an old certifier to a new certifier. The value is the driver parameter XML attribute. An alternate to this attribute is named-old-cert-pwd or old-cert-pwd. This attribute should be used in conjunction with certifier-name, old-cert-id or one of its alternates, cert-id or one of its alternates, and cert-pwd or one of its alternates.</p> <p>Example: drv-param-old-cert-pwd="mktg-cert-id-password".</p>	<p>As an attribute to a move command element.</p> <p>String</p>
enforce-unique-short-name Enforce Unique Short Name	<p>Specifies whether to enforce uniqueness of short names when registering a new user in Notes. The value is True or False. The default is False. If specified as True, and the Notes user registration process determines that if the short name for the new user already exists, the new user information is overlaid onto the existing Notes user of the same short name, thereby preventing the existence of a duplicate short name.</p> <p>Example: enforce-unique-short-name="true".</p>	<p>As an attribute to an add command element.</p> <p>String</p>
extended-ou Extended OU	<p>The value of the XML attribute is appended to the generated DN based on the selected certifier when registering a user.</p>	<p>As an attribute to an add or modify command element.</p> <p>String</p>
expire-term User ID file Expiration Term	<p>This XML attribute specifies the expiration term (specified in years) for the Notes User ID file of this user. Overrides the default Expiration Term parameter expiration-term in the driver configuration.</p>	<p>As an attribute to an add command element.</p> <p>Integer</p>
HTTPPassword Notes HTTP Password	<p>Specifies the user's Web (HTTP) password for Notes. This setting is ignored if the Allow HTTP Password Set parameter allow-http-password-set is set to False.</p>	<p>As an add-attr or modify-attr child element of an add or modify event.</p> <p>String</p>

Parameter Name and Common Description	Description	Valid Use
<p>immediate</p> <p>Immediate</p>	<p>Specifies whether a delete event performed by AdminP immediately deletes a user from the Notes Address Book, or waits until the AdminP request is processed at its scheduled interval. The specified value should be True or False. The default is False.</p> <p>Example: <code>immediate="true"</code>.</p>	<p>As an attribute to a <code>delete</code> command element.</p> <p>Boolean: true false</p>
<p>InternetAddress</p> <p>InternetAddress</p>	<p>This element specifies the user's Internet e-mail address in the Notes Address Book.</p>	<p>As an <code>add-attr</code> child element of an <code>add</code> event.</p> <p>String</p>
<p>internet-password-force-change</p> <p>Internet Password Force Change</p>	<p>Specifies whether a Notes user is forced to change his or her password on next login. The value of this attribute is True or False. If it is set to True, the user is forced to change his or her password on next login. If it is set to False (default), the user is not forced to change the password on next login. When this attribute is attached to a user <code>Add</code> or <code>Modify</code> event, an AdminP Set Password Information request is generated.</p> <p>Example: <code>internet-password-force-change="true"</code>.</p>	<p>As an attribute to an <code>add</code>, or <code>modify</code> command element.</p> <p>Boolean: true false</p>
<p>match-syntax</p> <p>Match Syntax</p>	<p>Specifies whether the Notes driver shim's query processor is to interpret the search values using literal Lotus Notes Formula Language Match syntax.</p> <p>If set to True, match syntax special characters (<code>\</code>, <code>{</code>, <code>}</code>, <code>?</code>, <code>*</code>, <code>&</code>, <code>!</code>, <code> </code>, <code>+</code>) are not used literally, but are used as wildcards to conform with the Lotus Script Formula Language's Match syntax.</p>	<p>Within an XDS query document, as an attribute to the <code>search-class</code> element, or as a <code>search-attr</code> element's child value element. Boolean: true false</p> <p>The default is False.</p>
<p>minimum-pwd-len</p> <p>Notes Password Strength</p>	<p>Specifies a password strength to apply to the User ID file of newly registered users. Value can be 0 - 16. Overrides the default Notes User ID minimum password strength parameter <code>minimum-pwd-len</code> in the driver configuration.</p>	<p>As an attribute to an <code>add</code> command element.</p> <p>Integer: 1-16</p>

Parameter Name and Common Description	Description	Valid Use
named-cert-pwd Certifier Password Key Name Reference	This XML attribute can be used instead of the Certifier Password <code>cert-pwd</code> XML attribute. This attribute specifies a named-password key name that holds the Notes Certifier ID password to be used with the Certifier ID file that is used to register this user object in the Notes Address Book. The Notes Certifier ID file and password are used to register user objects in the Notes Address Book. Overrides the default Notes Certifier ID file password parameter <code>cert-id-password</code> in the driver configuration. Alternates are <code>cert-pwd</code> and <code>drv-param-cert-pwd</code> .	As an attribute to an <code>add</code> command element. String
name-expire-date Name Expiration Date	Specifies the date when an old user name expires after a move user is performed by AdminP. This attribute only has effect when moving non-certified (Web) users. This attribute can be applied to override the default expiration term of 21 days. The date format should be specified in text, using the appropriate format of the locale of the Domino server. For example, in English, <code>name-expire-date="1 July 2010"</code> . An alternate to this attribute is <code>name-expiration-days</code> .	As an attribute to a <code>modify</code> command element. String
name-expiration-days Name Expiration Days	Specifies the number of days an old user name can be used before expiration after a move user is performed by AdminP. This attribute is effective only when moving non-certified (Web) users. This attribute can be applied to override the default expiration term of 21 days. An alternate to this attribute is <code>name-expiration-date</code> . Example: <code>name-expiration-days="14"</code> .	As an attribute to a <code>modify</code> command element. Integer

Parameter Name and Common Description	Description	Valid Use
<p>named-old-cert-pwd</p> <p>Named Old Certifier Password</p>	<p>Specifies the Named Password for the old Certifier ID file required to move a user in Notes from an old certifier to a new certifier. The value is the named password to be retrieved from the driver configuration. An alternate to this attribute is <code>drv-param-old-cert-pwd</code> or <code>old-cert-pwd</code>. This attribute should be used in conjunction with <code>certifier-name</code>, <code>old-cert-id</code> or one of its alternates, <code>cert-id</code> or one of its alternates, and <code>cert-pwd</code> or one of its alternates.</p> <p>Example: <code>named-old-cert-pwd="mktgNamedPwd"</code>.</p>	<p>As an attribute to a <code>move</code> command element.</p> <p>String</p>
<p>no-id-file</p> <p>No ID File</p>	<p>Specifies whether the Notes registration process creates an ID file for the new user. The value is True or False. The default is False.</p> <p>Example: <code>no-id-file="true"</code>.</p>	<p>As an attribute to an <code>add</code> command element.</p> <p>Boolean: <code>true</code> <code>false</code></p>
<p>notes-doc-lock-fail-action</p> <p>Notes Document Lock Failure Action</p>	<p>Specifies the status return code for the specific command if the Notes document locking method fails to obtain a lock.</p>	<p>As an attribute to an <code>add</code>, <code>modify</code>, or <code>modify-password</code> command element.</p> <p>String: <code>FATAL</code>, <code>RETRY</code>, <code>ERROR</code>, <code>WARNING</code>, <code>SUCCESS</code>, or <code>UNKNOWN</code></p>
<p>notes-policy-name</p> <p>Notes Explicit Policy Name</p>	<p>Specifies an explicit policy name to attach to a user when the user is registered. This attribute does not execute Notes registration policies or any other policies at registration time.</p>	<p>As an attribute to an <code>add</code> command element.</p> <p>String</p>
<p>notes-save-fail-action</p> <p>Notes Document Save Failure Action</p>	<p>Specifies the status return code for the specific command if the Notes document save method fails.</p>	<p>As an attribute to an <code>add</code>, <code>modify</code>, <code>rename</code>, <code>delete</code>, or <code>modify-password</code> command element.</p> <p>String: <code>FATAL</code>, <code>RETRY</code>, <code>ERROR</code>, <code>WARNING</code>, <code>SUCCESS</code>, or <code>UNKNOWN</code></p>

Parameter Name and Common Description	Description	Valid Use
notes-password-change-interval Notes Password Change Interval	Specifies a Notes user's password change interval. The value of this attribute is a number. The change interval specifies the number of days at which the user must supply a new password. The value defaults to zero. When this attribute is attached to a user add or modify event, an AdminP Set Password Information request is generated. Example: notes-password-change-interval="120".	As an attribute to an add or modify command element. Integer
notes-password-check-setting Notes Password Check Setting	Specifies a Notes user's password check setting. When this attribute is attached to a user Add or Modify event, an AdminP Set Password Information request is generated. Acceptable values are PWD_CHK_CHECKPASSWORD, PWD_CHK_DONTCHECKPASSWORD, and PWD_CHK_LOCKOUT. Example = notes-password-check-setting=" PWD_CHK_CHECKPASSWORD".	As an attribute to an add or modify command element. String or integer
notes-password-grace-period Notes Password Grace Period	Specifies a Notes user's password grace period. The value of this attribute is a number. The grace period specifies the number of days an old password is valid after it has expired. The value defaults to zero. When this attribute is attached to a user add or modify event, an AdminP Set Password Information request is generated. Example: notes-password-grace-period="10".	As an attribute to an add or modify command element. Integer

Parameter Name and Common Description	Description	Valid Use
old-certifier-name Old Certifier Name	<p>Specifies a certificate name that designates the origin of a Notes move operation. Use this parameter in conjunction with the parameter use-certificate-authority="true".</p> <p>If Domino CA services are functional, this custom parameter can be used instead of cert-id (or its alternate: drv-param-cert-id) and cert-pwd (or its alternates: drv-param-cert-pwd or named-cert-pwd) XML attributes.</p> <p>Example: old-certifier-name="\certwest\west"</p> <p>This custom parameter has a deprecated alternate of old-certificate-authority-org.</p>	<p>As an attribute to an add, or modify command element.</p> <p>String: Notes name of the old Notes Certifier</p>
old-cert-use-certificate-authority Old Certifier Use Certificate Authority	<p>Specifies if the Domino CA process is to be used for the old certifier that is required for a Notes move operation. It is used in conjunction with custom parameter old-certifier-name or its deprecated alternate old-certificate-authority-org.</p>	<p>As an attribute to an modify command element.</p> <p>Boolean: true false</p> <p>The default is False.</p>
old-certificate-authority-org Old Certificate Authority Organization	<p>This custom parameter is deprecated. The parameter old-certificat-authority-org specifies a certificate name that designates the origin of a Notes move operation. This is used in conjunction with custom parameter old-cert-use-certificate-authority="true".</p> <p>If Domino CA services are functional, this custom parameter can be used instead of old-cert-id (or its alternate: drv-param-old-cert-id) and old-cert-pwd (or its alternates: drv-param-old-cert-pwd or named-old-cert-pwd) XML attributes.</p> <p>Example: old-certificate-authority-org="\certwest\west"</p> <p>This custom parameter has an alternate of old-certifier-name.</p>	<p>As an attribute to an add, or modify command element.</p> <p>String: Notes name of the old Notes Certifier</p>

Parameter Name and Common Description	Description	Valid Use
old-cert-id Old Certification ID	<p>Specifies the old Certifier ID file required to move a user in Notes from an old certifier to a new certifier. The value is the full path and filename of the old Certifier ID file. An alternate to this attribute is <code>drv-param-old-cert-id</code>.</p> <p>This attribute should be used in conjunction with <code>certifier-name</code>, <code>old-cert-pwd</code> or one of its alternates, <code>cert-id</code> or one of its alternates, and <code>cert-pwd</code> or one of its alternates.</p> <p>Example: <code>old-cert-id="c:\lotus\notes\data\mktgcert.id"</code>.</p>	<p>As an attribute to a <code>move</code> command element.</p> <p>String</p>
old-cert-pwd Old Certification Password	<p>Specifies the password for the old Certifier ID file required to move a user in Notes from an old certifier to a new certifier. The value is the password string. An alternate to this attribute is <code>drv-param-old-cert-pwd</code> or <code>named-old-cert-pwd</code>. This attribute should be used in conjunction with <code>certifier-name</code>, <code>old-cert-id</code> or one of its alternates, <code>cert-id</code> or one of its alternates, and <code>cert-pwd</code> or one of its alternates.</p> <p>Example: <code>old-cert-pwd="mktg-password1"</code>.</p>	<p>As an attribute to a <code>move</code> command element.</p> <p>String</p>
recertify-user Recertify User	<p>Causes a recertify user request to be sent to AdminP. The attribute value is specified as True or False. Proper Certifier ID and password attributes (<code>cert-id</code>, <code>cert-pwd</code>, or equivalents) must be provided or the default certifier is applied to the AdminP recertification request.</p> <p>This attribute should be used in conjunction with <code>cert-id</code> or its alternate, and <code>cert-pwd</code> or one of its alternates. Can be used in conjunction with <code>expire-term</code> or <code>cert-expire-date</code> elements for specify the new expiration term of the user's certifier.</p> <p>Example: <code>recertify-user="true"</code>.</p>	<p>As an attribute to a <code>modify</code> command element.</p> <p>Boolean: true false</p>

Parameter Name and Common Description	Description	Valid Use
registration-dest-dn-check Notes Registration FullName Uniqueness Check	Specifies whether Notes driver shim should check for FullName field uniqueness of a new Notes person prior to the Notes registration process.	As an attribute to an add command element. Boolean: true false The default is True
remove-all-group-membership Group Membership Removal	This XML attribute indicates that this user object should be removed from the membership list of all groups in the Notes database, except for groups of type "Deny List" (GroupType=3). Valid values are True or False. The absence of this XML attribute defaults to False. This tag only applies to person (user) objects in the Notes Address Book.	As an attribute to a modify or delete command element. Boolean: true false
roaming-cleanup-period Roaming Cleanup Period	Specifies the Notes Client's cleanup interval in days for a roaming user when the roaming user's cleanup setting is set to C"LEANUP_EVERY_NDAYS." This attribute should be used in conjunction with roaming-user="true," and roaming-cleanup-setting="EVERY_NDAYS." Example: roaming-cleanup-period="90".	As an attribute to an add command element. Integer
roaming-cleanup-setting Roaming Cleanup Setting	Specifies the roaming user cleanup process for Notes Client data. Valid values are AT_SHUTDOWN, EVERY_NDAYS, NEVER, and PROMPT. The default value is NEVER. This attribute should be used in conjunction with roaming-user="true." Example: roaming-cleanup-setting="AT_SHUTDOWN"	As an attribute to an add command element. String
roaming-server Roaming Server	Specifies the name of the Domino server to store the roaming user data. This attribute should be used in conjunction with roaming-user="true." Example: roaming-server="CN=myserver2/O=acme".	As an attribute to an add command element. String
roaming-subdir Roaming Subdirectory	Specifies the subdirectory below the Domino server's data directory where user roaming data is stored. The last character of the value should be a file path separator (/ or \). Example: roaming-subdir="roamdata\"	As an attribute to an add command element. String

Parameter Name and Common Description	Description	Valid Use
roaming-user Roaming User	Specifies whether the Notes registration process creates this user with roaming capabilities. The value is True or False. The default is False. Example: <code>roaming-user="true"</code> .	As an attribute to an <code>add</code> command element. Boolean: true false
store-useridfile-in-ab Store User ID File In Notes Address Book	This XML attribute specifies if the driver attaches the user ID file for this user to its user object in the Notes Address Book at registration time. Setting the attribute to True causes this registered user object in the Notes Address Book to be created with an attached user ID file. Setting the attribute to False causes this registered user object in the Notes Address Book to be created without an attached user ID file. Overrides the default Store UserID in Address Book parameter <code>store-id-ab-flag</code> in the driver configuration.	As an attribute to an <code>add</code> command element. Boolean: true false
sync-internet-password Synchronize Internet Password	Specifies whether a user's Internet password (HTTPPassword) is synchronized to match the user's Notes Client ID password, by means of the background processes of the Domino server. The value is True or False. The default is False. Example: <code>sync-internet-password="true"</code> .	As an attribute to an <code>add</code> command element. Boolean: true false
tell-adminp-process Domino Console Command	Specifies the Domino console command to perform after an AdminP request has been performed by the Notes driver shim. For Domino console commands to succeed, the Notes Driver user must have appropriate Domino Console privileges granted. Example: <code>tell-adminp-process="tell adminp process new"</code> . See the instructions in “TELL AdminP Commands” on page 96 .	As an attribute to an <code>add</code> , <code>modify</code> , <code>move</code> , <code>delete</code> command element. String

Parameter Name and Common Description	Description	Valid Use
update-addressbook Register Users in Notes Address Book	<p>This XML attribute specifies if the driver puts registered user objects in the Notes Address Book. Setting the attribute to True causes registered users to be placed in the address book. Setting the attribute to False causes users to be registered (that is, a Certifier ID file is created for the user) without the user object being placed into the Notes Address Book.</p> <p>Overrides the default Update Address Book parameter <code>update-ab-flag</code> in the driver configuration.</p>	<p>As an attribute to an <code>add</code> command element.</p> <p>Boolean: true false</p>
use-certificate-authority Use Certificate Authority	<p>Specifies if the Domino CA process should be used to register, recertify, rename, or move a user. Requires <code>certify-name</code> to be provided, instead of <code>cert-id</code> (or its alternate: <code>drv-param-cert-id</code>) and <code>cert-pwd</code> (or one of its alternates: <code>drv-param-cert-pwd</code> or <code>named-cert-pwd</code>).</p>	<p>As an attribute to an <code>add</code>, or <code>modify</code> command element.</p> <p>Boolean: true false</p> <p>The default is False</p>
user-id-file ID File Name	<p>This XML attribute specifies the filename to be used for the user's ID file. The filename does not include the file path. When this XML attribute is absent, a default filename is generated by the Notes driver by using the first and last name attributes of the user (<code>FirstNameLastName.id</code>).</p>	<p>As an attribute to an <code>add</code> command element.</p> <p>String</p>
user-id-path ID File Path	<p>This XML attribute specifies the file path to the Notes User ID file storage location to be used when creating the user's ID file. The new ID file is placed in this location. The full path of the folder should be represented with respect to the operating system hosting Domino. Overrides the default Notes User ID certificate location parameter <code>cert-path</code> in the driver configuration.</p>	<p>As an attribute to an <code>add</code> command element.</p> <p>String</p>
user-pwd Notes Password	<p>The user's Notes password used to create the user's ID file (Certifier). Overrides the default Notes Password parameter <code>default-password</code> in the driver configuration.</p>	<p>As an attribute to an <code>add</code> command element.</p> <p>String</p>

ACL Custom Parameters

The following table lists the XML element attributes that can be inserted in the `add` or `modify` command element in an XDS document that is submitted to the Notes driver shim to appropriately configure the synchronized database's ACL settings. The first column of the table contains the parameter name followed by its common description. The parameters are alphabetized according to the XML parameter name.

The third column of the following table explains how to add parameter into the Driver Parameters XML Editor.

Table 5-5 ACL Custom Parameters

Parameter Name and Common Description	Description	How to Define Driver Parameters
<code>acl-admin-names</code> ACL Admin Name Modifier	The ACL <code>isAdminNames</code> property indicates whether the administration server can modify the names fields in this database.	As an attribute to an <code>add</code> , <code>modify</code> , or <code>delete</code> command element. Boolean: true false
<code>acl-admin-reader-author</code> ACL Admin Reader-Author Modifier	The ACL <code>isAdminReaderAuthor</code> property indicates whether the administration server can modify the Readers and Authors fields in this database.	As an attribute to an <code>add</code> , <code>modify</code> , or <code>delete</code> command element. Boolean: true false
<code>acl-administration-server</code> ACL Administration Server	The name of the Administration Server that can perform maintenance on this database. This value must be a Notes Distinguished Name of a valid Domino Administration Server.	As an attribute to an <code>add</code> , <code>modify</code> , or <code>delete</code> command element. String: distinguished Notes object name (such as "CN=Server1/O=myOrg")
<code>acl-entry-admin-reader-author</code> ACL Admin Reader-Author	Indicates if the <code>admin-reader-author</code> attribute is set.	As an attribute to an <code>add</code> , <code>modify</code> , or <code>delete</code> command element. Boolean: true false
<code>acl-entry-admin-server</code> ACL Admin Server	Indicates if the <code>admin-server</code> attribute is set. If it is set to True, this setting overrides the ACL Administration Server property and places this entry's name in the ACLs Administration Server property. See <code>acl-administration-server</code> .	As an attribute to an <code>add</code> , <code>modify</code> , or <code>delete</code> command element. Boolean: true false
<code>acl-entry-can-create-documents</code> ACL Create Documents	Indicates if the <code>can-create-documents</code> attribute is set.	As an attribute to an <code>add</code> , <code>modify</code> , or <code>delete</code> command element. Boolean: true false

Parameter Name and Common Description	Description	How to Define Driver Parameters
acl-entry-can-create-ls-or-java-agent ACL Create LS Or Java Agent	Indicates if the can-create-ls-or-java attribute is set.	As an attribute to an add, modify, or delete command element. Boolean: true false
acl-entry-can-create-personal-agent ACL Create Personal Agent	Indicates if the can-create-personal-agent attribute is set.	As an attribute to an add, modify, or delete command element. Boolean: true false
acl-entry-can-create-personal-folder ACL Create Personal Folder	Indicates if the can-create-personal-folder attribute is set.	As an attribute to an add, modify, or delete command element. Boolean: true false
acl-entry-can-create-shared-folder ACL Create SharedFolder	Indicates if the can-create-shared-folder attribute is set.	As an attribute to an add, modify, or delete command element. Boolean: true false
acl-entry-can-delete-documents ACL Delete Documents	Indicates if the can-delete-documents attribute is set.	As an attribute to an add, modify, or delete command element. Boolean: true false
acl-entry-can-replicate-or-copy-documents ACL Replicate Or Copy Documents	Indicates if the can-replicate-or-copy-documents attribute is set.	As an attribute to an add, modify, or delete command element. Boolean: true false
acl-entry-disable-role ACL Disable Role	Specifies the roles to set on the ACL.	As an attribute to an add, modify, or delete command element. String
acl-entry-enable-role ACL Enable Role	Specifies the roles to set on the ACL.	As an attribute to an add, modify, or delete command element. String

Parameter Name and Common Description	Description	How to Define Driver Parameters
acl-entry-level ACL Entry Level	Indicates the ACLEntry level. Valid strings include: MANAGER DESIGNER EDITOR AUTHOR READER DEPOSITOR NOACCESS	As an attribute to an add, modify, or delete command element. String or Integer
acl-entry-name ACL Entry Name	The name of the ACLEntry. If not present, this value defaults to the Notes Distinguished Name (FullName) of the current object being synchronized.	As an attribute to an add, modify, or delete command element. String: distinguished Notes object name (i.e. "CN=John Doe/OU=myOrgUnit/O=myOrg")
acl-entry-public-reader ACL Public Reader	Indicates if the public-reader attribute is set.	As an attribute to an add, modify, or delete command element. Boolean: true false
acl-entry-public-writer ACL Public Writer	Indicates if the public-writer attribute is set.	As an attribute to an add, modify, or delete command element. Boolean: true false
acl-entry-remove ACL Entry Remove	Indicates if the ACLEntry is to be removed from the ACL record of the database.	As an attribute to an add, modify, or delete command element. Boolean: true false
acl-entry-server ACL Server	Indicates if the ACL Server attribute is set.	As an attribute to an add, modify, or delete command element. Boolean: true false
acl-entry-user-type ACL User Type	Indicates the ACLEntry user type. Valid strings include: MIXED_GROUP PERSON PERSON_GROUP SERVER SERVER_GROUP UNSPECIFIED	As an attribute to an add, modify, or delete command element. String or Integer
acl-extended-access ACL Extended Access	The ACL isExtendedAccess property indicates whether extended access is enabled for this database.	As an attribute to an add, modify, or delete command element. Boolean: true false
acl-internet-level ACL Internet Level	The maximum internet access level for this database. Valid strings include: MANAGER DESIGNER EDITOR AUTHOR READER DEPOSITOR NOACCESS	As an attribute to an add, modify, or delete command element. String or Integer

Parameter Name and Common Description	Description	How to Define Driver Parameters
acl-uniform-access ACL Uniform Access	The ACL isUniformAccess property indicates whether a consistent ACL is enforced across all replicas of this database.	As an attribute to an add, modify, or delete command element. Boolean: true false

Table 5-6 ACL Description and Its Java ACL Constant

ACL Description	Notes Java ACL Constant
NOACCESS DEPOSITOR READER AUTHOR	ACL.LEVEL_NOACCESS ACL.LEVEL_DEPOSITOR ACL.LEVEL_READER
EDITOR DESIGNER MANAGER	ACL.LEVEL_AUTHOR ACL.LEVEL_EDITOR ACL.LEVEL_DESIGNER ACL.LEVEL_MANAGER

mailfile Custom Parameters

The following table lists the XML element attributes that can be inserted into the add command element in an XDS document that is submitted to the Notes driver shim to appropriately configure a mailfile database. The first column of the table contains the parameter name followed by its common description. The parameters are alphabetized according to the XML parameter name.

The third column of the following table explains how to add parameter into the Driver Parameters XML Editor..

XML element attributes used for mailfile replication settings (prefixed with mailfile-) can only be used within add command elements. These attributes are divided into mailfile-ACL and MailFile Rep attributes in this table.

Table 5-7 Mailfile Custom Parameters

Parameter Name and Common Description	Description	How to Define Driver Parameters
mail-acl-manager-id Mailfile ACL Manager ID	Specifies the UNID of a user to be given manager credentials on the ACL of the mailfile of the newly created user. An alternate is mail-acl-manager-name. Example: mail-acl-manager-id="BB888BB0C35D13EC87256EA8006296CE" As of NotesDriverShim v3.5, mail-acl-manager-id can appropriately handle Notes Person UNID values and Notes Group UNID values.	As an attribute to an add command element.

Parameter Name and Common Description	Description	How to Define Driver Parameters
mail-acl-manager-name Mailfile ACL Manager Name	Specifies the name of a user to be given manager credentials on the ACL of the mailfile of the newly created user. An alternate is mail-acl-manager-id. Example: mail-acl-manager-name="CN=Notes Admin/O=acme"	As an attribute to an add command element.
mail-acl-manager-group Mailfile ACL Manager Group	Specifies the name of a Notes group or groups to be given manager credentials on the ACL of the mailfile of the newly created user. The ACL entry type created when using this attribute is MIXED_GROUP. More than one group name can be specified by using a semicolon separator. Example: mail-acl-manager-group="LocalDomainAdmins;MailAdmins".	As an XML attribute to an add command element. String - name of Notes Group (LocalDomainAdmins).
MailDomain MailDomain	Specifies the name of the Notes Mail Domain when creating an e-mail database file.	As an add-attr child element of an add event. String
MailFile MailFile	Specifies the filename to be used when creating the user's e-mail database file. The filename does not include the file path. When this tag is absent, a default filename is generated by the Notes driver by using the first and last name attributes of the user (FirstNameLastName.nsf).	As an add-attr child element of an add event. String
mail-file-action MailFile Action	Specifies the AdminP action to perform on the mailbox of a deleted user. This action is included in an AdminP user delete request. Acceptable values are ALL, HOME, and NONE. The default value is NONE. ALL indicates to delete the mailbox on the home mail server and all mailbox replicas. HOME indicates to delete the mailbox on only the home mail server. All AdminP delete mailbox requests must be approved by a Domino Administrator before they are performed. Example: mail-file-action="ALL"	As an attribute to a delete command element.

Parameter Name and Common Description	Description	How to Define Driver Parameters
mail-file-inherit-flag Database Inheritance for Mail File Template	<p>This XML attribute specifies whether database structures based on a particular template are updated when that template is updated. Its value can be <code>True</code> or <code>False</code>.</p> <p>The default (the absence of this tag) is <code>True</code>.</p> <p>You can override the default and set this XML attribute to <code>False</code> if you don't want a change to a mail file template to affect existing database design.</p>	<p>As an attribute to an <code>add</code> command element.</p> <p>Boolean: <code>true</code> <code>false</code></p>
mail-file-subdir MailFile Subdirectory	<p>Specifies the subdirectory below the Domino server's data directory where the mailfile of a new user should be created.</p> <p>Example: <code>mail-file-subdir="mail-dbs"</code></p>	<p>As an attribute to an <code>add</code> command element.</p>
mail-file-quota Mail File Size Quota	<p>This XML attribute specifies the value of the mail file quota (size in KB) that is applied to the e-mail database file when it is created.</p>	<p>As an attribute to an <code>add</code> command element.</p> <p>Integer</p>
mailfile-acl-administration-server MailFile ACL Administration Server	<p>The name of the Administration Server that can perform maintenance on this database. This value must be a Notes Distinguished Name of a valid Domino Administration Server.</p>	<p>As an attribute to an <code>add</code> command element.</p> <p>String: distinguished Notes object name (i.e. <code>"CN=Server1/O=myOrg"</code>)</p>
mailfile-acl-admin-names MailFile ACL Admin Names	<p>The <code>ACL isAdminNames</code> property indicates whether the administration server can modify the names fields in this database.</p>	<p>As an attribute to an <code>add</code> command element.</p> <p>Boolean: <code>true</code> <code>false</code></p>
mailfile-acl-admin-reader-author MailFile ACL Admin Reader Author	<p>The <code>ACL isAdminReaderAuthor</code> property indicates whether the administration server can modify the Readers and Authors fields in this database.</p>	<p>As an attribute to an <code>add</code> command element.</p> <p>Boolean: <code>true</code> <code>false</code></p>
mailfile-acl-entry-admin-reader-author MailFile ACL Entry Admin Reader-Author	<p>Indicates if the <code>admin-reader-author</code> attribute is set.</p>	<p>As an attribute to an <code>add</code> command element.</p> <p>Boolean: <code>true</code> <code>false</code></p>

Parameter Name and Common Description	Description	How to Define Driver Parameters
mailfile-acl-entry-admin-server MailFile ACL Entry Admin Server	Indicates if the <code>admin-server</code> attribute is set. If set to True, this setting overrides the ACL Administration Server property and places this entry's name in the ACLs Administration Server property. See <code>acl-administration-server</code> .	As an attribute to an add command element. Boolean: true false
mailfile-acl-entry-can-create-documents MailFile ACL Entry Create Documents	Indicates if the <code>can-create-documents</code> attribute is set.	As an attribute to an add command element. Boolean: true false
mailfile-acl-entry-can-create-ls-or-java-agent MailFile ACL Entry Create LS Or Java Agent	Indicates if the <code>can-create-ls-or-java</code> attribute is set.	As an attribute to an add command element. Boolean: true false
mailfile-acl-entry-can-create-personal-agent MailFile ACL Entry Create Personal Agent	Indicates if the <code>can-create-personal-agent</code> attribute is set.	As an attribute to an add command element. Boolean: true false
mailfile-acl-entry-can-create-personal-folder MailFile ACL Entry Create Personal Folder	Indicates if the <code>can-create-personal-folder</code> attribute is set.	As an attribute to an add command element. Boolean: true false
mailfile-acl-entry-can-create-shared-folder MailFile ACL Entry Create Shared Folder	Indicates if the <code>can-create-shared-folder</code> attribute is set.	As an attribute to an add command element. Boolean: true false
mailfile-acl-entry-can-delete-documents MailFile ACL Entry Delete Documents	Indicates if the <code>can-delete-documents</code> is set.	As an attribute to an add command element. Boolean: true false

Parameter Name and Common Description	Description	How to Define Driver Parameters
mailfile-acl-entry-can-replicate-or-copy-documents MailFile ACL Entry Replicate Or Copy Documents	Indicates if the <code>can-replicate-or-copy-documents</code> attribute is set.	As an attribute to an add command element. Boolean: true false
mailfile-acl-entry-disable-role MailFile ACL Entry Disable Role	Specifies the roles to set on the ACL (by default, mailfile ACLs do not have any roles defined).	As an attribute to an add command element. String
mailfile-acl-entry-enable-role MailFile ACL Entry Enable Role	Specifies the roles to set on the ACL (by default, mailfile ACLs do not have any roles defined).	As an attribute to an add command element. String
mailfile-acl-entry-level MailFile ACL Entry Level	The equivalent to <code>mailfile-acl-level</code> . Indicates the ACL entry level. Valid strings include: MANAGER DESIGNER EDITOR AUTHOR READER DEPOSITOR NOACCESS	As an attribute to an add command element. String or Integer
mailfile-acl-entry-name MailFile ACL Entry Name	The name of the ACL entry. If not present, this value defaults to the Notes Distinguished Name (FullName) of the current object being synchronized.	As an attribute to an add command element. String: distinguished Notes object name (such as "CN=John Doe/OU=myOrgUnit/O=myOrg")
mailfile-acl-entry-public-reader MailFile ACL Entry Public Reader	Indicates if the <code>public-reader</code> attribute is set.	As an attribute to an add command element. Boolean: true false
mailfile-acl-entry-public-writer MailFile ACL Entry Public Writer	Indicates if the <code>public-writer</code> attribute is set.	As an attribute to an add command element. Boolean: true false

Parameter Name and Common Description	Description	How to Define Driver Parameters
mailfile-acl-entry-remove MailFile ACL Entry Remove	Indicates if the ACLEntry is to be removed from the ACL record of the mailfile database.	As an attribute to an add command element. Boolean: true false
mailfile-acl-entry-server MailFile ACL Entry Server	Indicates if the ACLEntry server attribute is set	As an attribute to an add command element. Boolean: true false
mailfile-acl-entry-user-type MailFile ACL Entry User Type	Indicates the ACLEntry user type. Valid strings include: MIXED_GROUP PERSON PERSON_GROUP SERVER SERVER_GROUP UNSPECIFIED	As an attribute to an add command element. String or Integer
mailfile-acl-extended-access MailFile ACL Extended Access	The ACL isExtendedAccess property indicates whether extended access is enabled for this database.	As an attribute to an add command element. Boolean: true false
mailfile-acl-internet-level MailFile ACL Internet Level	The maximum Internet access level for this database. Valid strings include: MANAGER DESIGNER EDITOR AUTHOR READER DEPOSITOR NOACCESS	As an attribute to an add command element. String or Integer
mailfile-acl-level MailFile ACL Control	The default ACL setting for the newly created mail file of newly created user objects. Valid values are: NOACCESS, DEPOSITOR, READER, AUTHOR, EDITOR, DESIGNER, and MANAGER. Values can be specified either as the Java ACL constant or the role name, as found in Table 5-6 on page 77 . This attribute should be added in the same rule where the certification attributes are calculated and set and it should be added using the same XSL constructs. Overrides the default Mail File ACL Level parameter mailfile-acl-level in the driver configuration.	As an attribute to an add command element.
mailfile-acl-uniform-access MailFile ACL Uniform Access	The ACL isUniformAccess property indicates whether a consistent ACL is enforced across all replicas of this database.	As an attribute to an add command element. Boolean: true false

Parameter Name and Common Description	Description	How to Define Driver Parameters
<p>mailfile-adminp-create</p> <p>Administration Process Mailfile Creation</p>	<p>Specifies if the creation of a mailfile is to be performed via AdminP (in the background). When it is set to True, the Notes user's mailfile is created via AdminP.</p> <p>Example: mailfile-adminp-create="true".</p>	<p>As an attribute to an add command element.</p> <p>Boolean: true false</p>
<p>mailfile-calprofile-create</p> <p>Mailfile Owner Attribute Creation</p>	<p>Specifies if a mailfile calendar profile document is created within a newly created mailfile, indicating the mailfile owner for the mailfile database.</p>	<p>As an attribute to an add, or modify command element.</p> <p>Boolean: true false</p> <p>Default is True</p>
<p>mailfile-calprofile-owner</p> <p>Mailfile Owner</p>	<p>Specifies the mailfile owner field that is inserted in the mailfile calendar profile document of the a newly created mailfile database.</p>	<p>As an attribute to an add, or modify command element.</p> <p>String: The owner's name of the newly created Notes mailfile. The name should be in Notes canonical format.</p>
<p>mailfile-template</p> <p>MailFileTemplate</p>	<p>This XML attribute specifies the filename of the .ntf database template to use when creating the user's new mail file for an e-mail account. This template must be accessible to the Domino server in the Domino data folder. Overrides the default Mail File Template in the driver configuration.</p>	<p>As an attribute to an add command element</p>
<p>mailfile-rep-abstract</p> <p>MailFile Rep Abstract</p>	<p>Specifies whether large documents should be truncated and attachments removed during replication. Set it to True to truncate large documents and remove attachments, and to False to replicate large documents in their entirety.</p>	<p>As an attribute to an add command element.</p> <p>Boolean: true false</p>
<p>mailfile-rep-background</p> <p>Background Mailfile Replica Creation</p>	<p>Specifies if creating a mailfile replica is performed via AdminP (in the background). When it is set to True, the mailfile replica is created via AdminP on the servers specified by the mailfile-rep-new-server custom parameter.</p> <p>Example: mailfile-rep-background="true".</p>	<p>As an attribute to an add command element.</p> <p>Boolean: true false</p>
<p>mailfile-rep-clear-history</p> <p>MailFile Rep Clear History</p>	<p>Set it to True to clear the replication history from the replication object, and to False to affect nothing.</p>	<p>As an attribute to an add command element.</p> <p>Boolean: true false</p>

Parameter Name and Common Description	Description	How to Define Driver Parameters
<p>mailfile-rep-cutoff-delete</p> <p>MailFile Rep Cutoff Delete</p>	<p>Specifies whether documents that are older than the cutoff date should be automatically deleted. The cutoff date is determined by today's date minus the cutoff interval (<code>mailfile-rep-cutoff-interval</code>). Set it to True to automatically delete documents that are older than the cutoff date, and to False to not delete old documents.</p>	<p>As an attribute to an add command element.</p> <p>Boolean: true false</p>
<p>mailfile-rep-cutoff-interval</p> <p>MailFile Rep Cutoff Interval</p>	<p>Specifies the number of days after which documents are automatically deleted if the CutoffDelete property is set (see <code>mailfile-rep-cutoff-delete</code>).</p>	<p>As an attribute to an add command element.</p> <p>Integer: numeric value</p>
<p>mailfile-rep-disabled</p> <p>MailFile Rep Disabled</p>	<p>Specifies whether replication is disabled. Set it to True to disable replication, and to False to enable replication.</p>	<p>As an attribute to an add command element.</p> <p>Boolean: true false</p>
<p>mailfile-rep-dest-server</p> <p>MailFile Rep Destination Server</p>	<p>Specifies the Domino destination server (When computer) of a replication entry (within the replication object). If specified, and the source server/destination server pair does not already exist within the replication entry list, a new replication entry is created. If this parameter is absent, the destination server defaults to "any server" (a hyphen "-" means any server). Used in connection with <code>mailfile-rep-src-server</code>.</p>	<p>As an attribute to an add command element.</p> <p>String: distinguished name of a replica Domino destination server, such as i.e. <code>CN=server1/O=acme</code>.</p>
<p>mailfile-rep-dont-send-local-security-updates</p> <p>MailFile Rep Don't Send Local Security Updates</p>	<p>Specifies whether local security (encryption) updates are sent. Set to True to not send local security updates, and False to send local security updates.</p>	<p>As an attribute to an add command element.</p> <p>Boolean: true false</p>
<p>mailfile-rep-entry-remove</p> <p>MailFile Rep Entry Remove</p>	<p>Set it to True to remove the current replication entry from the replication object, and set it to False to affect nothing. Used in connection with <code>mailfile-rep-src-server</code> and/or <code>mailfile-rep-dest-server</code>.</p>	<p>As an attribute to an add command element.</p> <p>Boolean: true false</p>

Parameter Name and Common Description	Description	How to Define Driver Parameters
<p>mailfile-rep-formula</p> <p>MailFile Rep Formula</p>	<p>Specifies the replication formula for a replication entry. By default, a new replication entry contains the @All formula. The formula must be a valid replication formula. Used in connection with mailfile-rep-src-server and/or mailfile-rep-dest-server.</p>	<p>As an attribute to an add command element.</p> <p>String: replication formula</p>
<p>mailfile-rep-immediate</p> <p>MailFile Rep Immediate</p>	<p>Indicates that database replication must begin immediately to the specified Domino server on which an existing database replica already exists.</p>	<p>As an attribute to an add command element.</p> <p>String: distinguished name of a replica Domino destination server, such as CN=server1/O=acme.</p>
<p>mailfile-rep-include-acl</p> <p>MailFile Rep Include ACL</p>	<p>Specifies the inclusion of the ACL during replication for a replication entry. Set it to True to include the ACL, and to False to exclude the ACL. Used in connection with mailfile-rep-src-server and/or mailfile-rep-dest-server.</p>	<p>As an attribute to an add command element.</p> <p>Boolean: true false</p>
<p>mailfile-rep-include-agents</p> <p>MailFile Rep Include Agents</p>	<p>Specifies the inclusion of agents during replication for a replication entry. Set it to True to include agents, and to False to exclude agents. Used in connection with mailfile-rep-src-server and/or mailfile-rep-dest-server.</p>	<p>As an attribute to an add command element.</p> <p>Boolean: true false</p>
<p>mailfile-rep-include-documents</p> <p>MailFile Rep Include Documents</p>	<p>Specifies the inclusion of documents during replication for a replication entry. Set it to True to include documents, and to False to exclude documents. Used in connection with mailfile-rep-src-server and/or mailfile-rep-dest-server.</p>	<p>As an attribute to an add command element.</p> <p>Boolean: true false</p>
<p>mailfile-rep-include-forms</p> <p>MailFile Rep Include Forms</p>	<p>Specifies the inclusion of forms during replication for a replication entry. Set it to True to include forms, and to False to exclude forms. Used in connection with mailfile-rep-src-server and/or mailfile-rep-dest-server.</p>	<p>As an attribute to an add command element.</p> <p>Boolean: true false</p>
<p>mailfile-rep-include-formulas</p> <p>MailFile Rep Include Formulas</p>	<p>Specifies the inclusion of formulas during replication for a replication entry. Set it to True to include formulas, and to False to exclude formulas. Used in connection with mailfile-rep-src-server and/or mailfile-rep-dest-server.</p>	<p>As an attribute to an add command element.</p> <p>Boolean: true false</p>

Parameter Name and Common Description	Description	How to Define Driver Parameters
<p>mailfile-rep-ignore-deletes</p> <p>MailFile Rep Ignore Deletes</p>	<p>Specifies whether outgoing deletions should not be replicated to other databases. Set it to True to not replicate outgoing deletions, and to False to replicate outgoing deletions.</p>	<p>As an attribute to an add command element.</p> <p>Boolean: true false</p>
<p>mailfile-rep-ignore-dest-deletes</p> <p>MailFile Rep Ignore Destination Deletes</p>	<p>Specifies whether incoming deletions should not be replicated to the current database. Set it to True to not replicate incoming deletions, and to False to replicate incoming deletions.</p>	<p>As an attribute to an add command element.</p> <p>Boolean: true false</p>
<p>mailfile-rep-new-db-name</p> <p>MailFile Rep New DB Name</p>	<p>The filename of the newly created replica. If mailfile-rep-new-db-name is not present, the filename of the original database is used. The default location of the new file is in the Domino server's data folder. Can be used in connection with mailfile-rep-new-server.</p>	<p>As an attribute to an add command element.</p> <p>String: file name of the new replica, such as mail/JohnDoeRep2.nsf.</p>
<p>mailfile-rep-new-server</p> <p>MailFile Rep New Server</p>	<p>The name of the Domino server where a new replica will be created. The Domino server must be accessible on the network. Depending on the size of the database, this might be a time-consuming process for the Notes driver shim. Can be used in connection with mailfile-rep-new-db-name.</p>	<p>As an attribute to an add command element.</p> <p>String: distinguished name of Domino server where a new replica will be created, such as CN=server1/O=acme.</p>
<p>mailfile-rep-priority</p> <p>MailFile Rep Priority</p>	<p>Specifies the replication priority. The choices are HIGH, MED, and LOW. The default is Medium (MED).</p>	<p>As an attribute to an add command element.</p> <p>String or integer</p>
<p>mailfile-rep-src-server</p> <p>MailFile Rep Source Server</p>	<p>Specifies the Domino source server (Receives from) of a replication entry within the replication object. If specified, and the source server/destination server pair does not already exist within the replication entry list, a new replication entry is created. If this parameter is absent, the source server defaults to "any server" (a hyphen "-" means any server). To be used in connection with mailfile-rep-dest-server.</p>	<p>As an attribute to an add command element.</p> <p>String: distinguished name of a replica Domino source server, such as CN=server2/O=acme.</p>

Parameter Name and Common Description	Description	How to Define Driver Parameters
mailfile-rep-view-list MailFile Rep View List	Specifies a list of view names to be replicated for a replication entry. The string specifies the views as a list, separating view names with semicolons, such as Inbox; Sent; Calendar; Meetings. Used in connection with mailfile-rep-src-server and/or mailfile-rep-dest-server.	As an attribute to an add command element. String: ViewList
mail-quota-warning-threshold MailFile Quota Warning Threshold	Specifies the value of the mailfile quota warning threshold (size in KB) that is applied to the e-mail database file when it is created. Example: mail-quota-warning-threshold="120000"	As an attribute to an add command element.
MailServer MailServer	This element specifies the name of the Notes Server where the mail file should be created when creating an e-mail account (mail database file).	As an add-attr child element of an add event. String
mail-server Mail Server	Specifies the mail server to be used to create a mailfile for a new user. This attribute overrides the value specified in the driver parameters. Example: mail-server="CN=ms2/O=acme" Alternate: See the MailServer custom parameter.	As an attribute to an add command element. String
mailsystem Mail System	Specifies the mail system type set for the new user being created. Valid values are NOTES, POP, INTERNET, OTHER, NONE. The default value is NOTES.	As an attribute to an add command element. String or integer
match-syntax Match Syntax	Specifies whether Notes driver shim's query processor is to interpret the search values by using literal Lotus Notes Formula Language Match syntax. If set to True, Match syntax special characters (\, {, }, ?, *, &, !, , +) are not used literally, but are used as wildcards to conform with the Lotus Script Formula Language's Match syntax.	Within an XDS query document, as an attribute to the search-class element, or as a search-attr element's child value element. Boolean: true false The default is False .

Rep Custom Parameters

The following table lists the XML element attributes that can be inserted into the `add` or `modify` command element in an XDS document that is submitted to the Notes driver shim to appropriately configure a synchronized database's replication options. The first column of the table contains the parameter name followed by its common description. The parameters are alphabetized according to the XML parameter name.

The third column of the following table explains how to add parameter into the Driver Parameters XML Editor.

Table 5-8 *Rep Custom Parameters*

Parameter Name and Common Description	Description	How to Define Driver Parameters
<code>rep-abstract</code> Rep Abstract	Specifies whether large documents should be truncated and attachments removed during replication. Set it to <code>True</code> to truncate large documents and remove attachments and to <code>False</code> to replicate large documents in their entirety.	As an attribute to an <code>add</code> , <code>modify</code> , or <code>delete</code> command element. Boolean: <code>true</code> <code>false</code>
<code>rep-background</code> Background Replica Creation	Specifies whether creating the synchronized database replica is performed via AdminP (in the background). When it is set to <code>True</code> , a replica is created via AdminP on the servers specified by the <code>rep-new-server</code> custom parameter. Example: <code>rep-background="true"</code> .	As an attribute to an <code>add</code> command element. Boolean: <code>true</code> <code>false</code>
<code>rep-clear-history</code> Rep Clear History	Set it to <code>True</code> to clear the replication history from the replication object, and to <code>False</code> to affect nothing.	As an attribute to an <code>add</code> , <code>modify</code> , or <code>delete</code> command element. Boolean: <code>true</code> <code>false</code>
<code>rep-cutoff-delete</code> Rep Cutoff Delete	Specifies whether documents that are older than the cutoff date should be automatically deleted. The cutoff date is determined by today's date minus the cutoff interval (<code>rep-cutoff-interval</code>). Set it to <code>True</code> to automatically delete documents that are older than the cutoff date, and to <code>False</code> to not delete old documents.	As an attribute to an <code>add</code> , <code>modify</code> , or <code>delete</code> command element. Boolean: <code>true</code> <code>false</code>
<code>rep-cutoff-interval</code> Rep Cutoff Interval	Specifies the number of days after which documents are automatically deleted if the <code>CutoffDelete</code> property is set (see <code>rep-cutoff-delete</code>).	As an attribute to an <code>add</code> , <code>modify</code> , or <code>delete</code> command element. Integer: numeric value

Parameter Name and Common Description	Description	How to Define Driver Parameters
rep-dest-server Rep Destination Server	Specifies the Domino destination server (When computer) of a replication entry (within the replication object). If specified, and the source server/destination server pair does not already exist within the replication entry list, a new replication entry is created. If this parameter is absent, the destination server defaults to "any server" (a hyphen "-" means any server). To be used in connection with rep-src-server.	As an attribute to an add, modify, or delete command element. String: distinguished name of a replica Domino destination server, such as CN=server1/O=acme.
rep-disabled Rep Disabled	Specifies whether replication is disabled. Set it to True to disable replication, and to False to enable replication.	As an attribute to an add, modify, or delete command element. Boolean: true false
rep-dont-send-local-security-updates Rep Don't Sent Local Security Updates	Specifies whether local security (encryption) updates are sent. Set it to True to not send local security updates, and to False to send local security updates.	As an attribute to an add, modify, or delete command element. Boolean: true false
rep-entry-remove Rep Entry Remove	Set it to True to remove the current replication entry from the replication object, and to False to affect nothing. Used in connection with rep-src-server and/or rep-dest-server.	As an attribute to an add, modify, or delete command element. Boolean: true false
rep-formula Rep Formula	Specifies the replication formula for a replication entry. By default, a new replication entry contains the @All formula. The formula must be a valid replication formula. Used in connection with rep-src-server and/or rep-dest-server.	As an attribute to an add, modify, or delete command element String: replication formula
rep-include-acl Rep Include ACL	Specifies the inclusion of the ACL during replication for a replication entry. Set it to True to include the ACL, or to False to exclude the ACL. Used in connection with rep-src-server and/or rep-dest-server.	As an attribute to an add, modify, or delete command element. Boolean: true false
rep-include-agents Rep Include Agents	Specifies the inclusion of agents during replication for a replication entry. Set it to True to include agents, or to False to exclude agents. Used in connection with rep-src-server and/or rep-dest-server.	As an attribute to an add, modify, or delete command element. Boolean: true false

Parameter Name and Common Description	Description	How to Define Driver Parameters
rep-include-documents Rep Include Documents	Specifies the inclusion of documents during replication for a replication entry. Set it to True to include documents, or to False to exclude documents. Used in connection with <code>rep-src-server</code> and/or <code>rep-dest-server</code> .	As an attribute to an <code>add</code> , <code>modify</code> , or <code>delete</code> command element. Boolean: true false
rep-include-forms Rep Include Forms	Specifies the inclusion of forms during replication for a replication entry. Set it to True to include forms, or to False to exclude forms. Used in connection with <code>rep-src-server</code> and/or <code>rep-dest-server</code> .	As an attribute to an <code>add</code> , <code>modify</code> , or <code>delete</code> command element. Boolean: true false
rep-include-formulas Rep Include Formulas	Specifies the inclusion of formulas during replication for a replication entry. Set it to True to include formulas, or to False to exclude formulas. Used in connection with <code>rep-src-server</code> and/or <code>rep-dest-server</code> .	As an attribute to an <code>add</code> , <code>modify</code> , or <code>delete</code> command element. Boolean: true false
rep-ignore-deletes Rep Ignore Deletes	Specifies whether outgoing deletions should not be replicated to other databases. Set it to True to not replicate outgoing deletions, or to False to replicate outgoing deletions.	As an attribute to an <code>add</code> , <code>modify</code> , or <code>delete</code> command element. Boolean: true false
rep-ignore-dest-deletes Rep Ignore Destination Deletes	Specifies whether incoming deletions should not be replicated to the current database. Set it to True to not replicate incoming deletions, or to False to replicate incoming deletions.	As an attribute to an <code>add</code> , <code>modify</code> , or <code>delete</code> command element. Boolean: true false
rep-immediate Rep Immediate	Indicates that database replication must begin immediately to the specified Domino server on which a existing database replica already exists.	As an attribute to an <code>add</code> , <code>modify</code> , or <code>delete</code> command element. String: distinguished name of a replica Domino destination server (such as <code>CN=server1/Acme</code>).
rep-new-db-name Rep New Database Name	The filename of the newly created replica. If <code>rep-new-db-name</code> is not present, the filename of the original database is used. The default location of the new file is in the Domino server's data folder. Used in connection with <code>rep-new-server</code> .	As an attribute to an <code>add</code> , <code>modify</code> , or <code>delete</code> command element. String: file name of the new replica, such as <code>mail/JohnDoeRep2.nsf</code> .

Parameter Name and Common Description	Description	How to Define Driver Parameters
rep-new-server Rep New Server	The name of the Domino server where a new replica will be created. The Domino server must be accessible on the network. Depending on the size of the database, this might be a time-consuming process for the Notes driver shim. Can be used in connection with rep-new-db-name.	As an attribute to an add, modify, or delete command element. String: distinguished name of Domino server where a new replica will be created, such as CN=server1/O=acme.
rep-priority Rep Priority	Specifies the replication priority. The default is Medium (MED).	As an attribute to an add, modify, or delete command element. String: HIGH, MED, LOW
rep-src-server Rep Source Server	Specifies the Domino source server (Receives from) of a replication entry (within the replication object). If specified, and the source server/destination server pair does not already exist within the replication entry list, a new replication entry is created. If this parameter is absent, the source server defaults to "any server" (a hyphen "-" means any server). To be used in connection with rep-dest-server.	As an attribute to an add, modify, or delete command element. String: distinguished name of a replica Domino source server, such as CN=server2/O=acme.
rep-view-list Rep View List	Specifies a list of view names to be replicated for a replication entry. The string specifies the views as a list, separating view names with semicolons, such as Inbox; Sent; Calendar; Meetings. Used in connection with rep-src-server and/or rep-dest-server.	As an attribute to an add, modify, or delete command element. String: ViewList

Example Files

You can configure and create rules, policies, and style sheets by using iManager. (Style sheets are XSLT documents that define transformations or modifications of XML documents.)

Identity Manager provides the following examples:

NotesMoveSample.xml: This sample policy is a Publisher channel policy that contains logic to determine Identity Vault object placement when an associated Notes object is moved.

In the Import Drivers Wizard, this policy is named Notes - Move Sample and is available under the Additional Policies heading. See ["Determining Identity Vault Object Placement When a Notes Object is Moved"](#) on page 37.

NotesReturnEmail.xml: This sample policy is a Command Transformation policy designed to generate an e-mail address for user Add events on the Subscriber channel.

It is necessary only when upgrading the driver shim and configuration from 1.x to 3. The policy is already a part of the sample configuration provided with the 2.1 version of the driver and later.

In the Import Drivers Wizard, this policy is named Notes - Return Email Address and is available under the **Additional Policies** heading.

Cert.xsl: An Output Transformation style sheet that contains logic to determine which Notes Certifier to use based on the src-dn attribute on the add XML attribute.

See [“Automatically Determining Which Certifier to Use” on page 39](#) for more information.

Override.xsl: Shows an example of how to use attributes to override parameters. See the list in [Table 5-4 on page 56](#).

Placemove.xsl: An Input Transformation style sheet that contains logic to determine placement containment when synchronizing a move from Lotus Notes to the Identity Vault.

See [“Determining Identity Vault Object Placement When a Notes Object is Moved” on page 37](#) for more information.

AddUniqueName.xsl: Simple example of how a unique name can be created for a Notes user.

EntitlementGrpCmdCompletionSS.xsl: If you choose to use Role-Based Entitlements when importing the sample configuration, this style sheet is included. This is an example of how to process the payload of an `operation-data` element.

NotesCertifierSelectionSampleSS.xsl: Based on `Cert.xsl`, this shows an enhanced sample of how to utilize multiple Notes Certifiers. It demonstrates using named passwords in multiple ways. See [“Automatically Determining Which Certifier to Use” on page 39](#) and [“Using Named Passwords” on page 40](#).

NOTE: Most of these files are located in the product distribution in `windows/setup/drivers/lotusNotes/rules`. Some of them are used in the sample driver configuration in Designer.

Synchronizing a Database Other Than `names.nsf`

Although the driver is intended as a directory synchronization driver for the Notes directory, it is possible to configure the driver to use a Notes database other than `names.nsf`. In this case, you need to make sure that the Schema Mapping policy is appropriate for the schema in the target database.

Schema Mapping Type and Form

In a Notes names and address book, each document contains a **Type** field as well as a **Form** field. The **Type** field supports the LDAP Server on Notes by providing a class name. The **Form** field is a standard Notes document field that indicates which form should be used to display the document. The **Form** item is not required, and if it is not present, the Notes Client uses a default form.

Identity Manager does not provide the ability to map a single DS attribute to multiple target application attributes. This means that the Schema Mapping policy can't be used to map the object class to Form and Type. To handle this, the Driver Configuration asks if the directory database is really a Notes directory. If it is, the class name on DSEntry (translated into the Notes namespace) is used as the value for Type.

The object-class attribute on the DSAttribute object can be used to update the Form item if it is specified in the Schema Mapping policy. This provides a way to set both of those attributes, as well as providing mappings to allow the Type and Form values to differ. If the Schema Mapping policy contains a mapping between an Identity Vault attribute and Form, it might be necessary to translate the content of the Identity Vault attribute. This can be done by using an Output Transform policy. Conversely, an Input Transform policy is used to translate content from the Notes namespace to the Identity Vault namespace.

If the directory source is not a Notes directory, the driver writes no Type item and the Class Name attribute is written to the Form item. If a Form item appears in the filter, the driver and ndsrep ignore it.

If the driver is configured against the Notes directory, the translated values for classname are written to a Type item in the Notes database, and Form can be included in the Schema Mapping policy. If the driver is configured against a Notes database other than the directory, the translated values for classname are written to a Form item in the Notes database, and Form might not be included in the Schema Mapping policy.

Move/Rename

Move and Rename events are not supported in the default configuration. However, you can synchronize a Move or Rename event in Notes across the Publisher channel and into the Identity Vault if you modify the default Schema Map and the default Publisher Filter, and add a policy.

In addition, you can synchronize a Move or Rename event on the Subscriber channel, enable AdminP support, and add policies that provide the necessary attributes.

- ♦ [“Subscriber Channel” on page 93](#)
- ♦ [“Publisher Channel” on page 95](#)
- ♦ [“Considerations for Using AdminP” on page 95](#)

Subscriber Channel

- ♦ [“Moving a User” on page 94](#)
- ♦ [“Modifying a User Name in Identity Vault \(a Rename Event in Notes\)” on page 94](#)
- ♦ [“Renaming a Group” on page 95](#)

Moving a User

- 1 Make sure you have reviewed [“Considerations for Using AdminP” on page 95](#).
- 2 Make sure you have turned on support for the AdminP process by adding the following parameter to the Subscriber Options in the driver parameters:

```
<allow-adminp-support display-name="Allow Domino AdminP Support">True</allow-adminp-support>
```

See [Allow Domino AdminP Support in “Subscriber Options” on page 44](#).

- 3 Create driver policies that add the following attributes to the Move event:
 - ◆ The certifier name of the destination certifier in Notes.
 - ◆ The Certifier ID and a password for the destination certifier in Notes (the certifier that the user is going to)
 - ◆ The old Certifier ID and password for the source certifier in Notes (the certifier that the user is coming from)

A sample of a command to the driver shim that moves a user is included in [“Sample for Moving a User” on page 135](#).

Modifying a User Name in Identity Vault (a Rename Event in Notes)

When a user's given name, middle initial, or surname changes in Identity Vault, this event can cause the Rename of an object in Lotus Notes. If AdminP support is enabled, you can perform the Rename in Notes.

- 1 Make sure you have reviewed [“Considerations for Using AdminP” on page 95](#).
- 2 Make sure you have turned on support for the AdminP process by adding the following parameter to the Subscriber Options in the driver parameters:

```
<allow-adminp-support display-name="Allow Domino AdminP Support">True</allow-adminp-support>
```

See [Allow Domino AdminP Support in “Subscriber Options” on page 44](#).

- 3 Create driver policies that provide the correct certifier and password for the Notes user that is being renamed.

If a certifier and password are not specified in the event, the default certifier and password specified in the driver parameters are used.

A sample of a command to the driver shim that renames a user is included in [“Sample for Renaming: Modifying a User Last Name” on page 133](#).

Renaming a Group

If AdminP support is enabled, you can rename groups. Rename events from Identity Vault for groups do not require you to create any additional driver policies.

Rename events from Identity Vault can be applied only to group objects in Notes. (For users, the driver shim uses an appropriate modify event to rename a user in Notes, as described in [“Modifying a User Name in Identity Vault \(a Rename Event in Notes\)”](#) on page 94.)

- 1 Make sure you have reviewed [“Considerations for Using AdminP”](#) on page 95.
- 2 Make sure you have turned on support for the AdminP process by adding the following parameter to the Subscriber Options in the driver parameters:

```
<allow-adminp-support display-name="Allow Domino AdminP Support">True</allow-adminp-support>
```

See [Allow Domino AdminP Support](#) in [“Subscriber Options”](#) on page 44.

Publisher Channel

To enable the one-way object move/rename synchronization:

- 1 Modify the schema mapping to map Identity Vault Full Name to Notes FullName.
- 2 Enable the Full Name attribute in the Publisher filter.
- 3 Make sure that the Full Name attribute in the Subscriber filter is not enabled.
- 4 Make sure that the Public/Private AB setting is Yes in the driver configuration parameters.

The Public/Private AB setting is the same as the `is-directory` driver parameter; see [Table 5-1 on page 41](#) for more information.

- 5 Use a policy in your driver configuration like the one described in [“Determining Identity Vault Object Placement When a Notes Object is Moved”](#) on page 37.

After these modifications have been made, ndsrep detects changes to FullName. Because FullName contains both name and location information in a single attribute, ndsrep cannot distinguish between a Move and a Rename. Therefore, a change to FullName initiates both a Move event and a Rename event to be synchronized into Identity Vault.

Considerations for Using AdminP

The Administration Process (AdminP) is a program that automates many routine administrative tasks in Lotus Note. AdminP support provides several new features, but to use them effectively you must keep in mind the following:

- ♦ You need to have an understanding of AdminP and of Notes administration.
- ♦ A success message returned to the driver for an AdminP request means only that the request was successfully received by AdminP, not that it was completed successfully.
- ♦ AdminP requests made by the driver are not completed until AdminP attempts the action. The timing depends on the configuration of the AdminP by the Notes administrator, the Domino server network, and the complexity of the action requested.

- ◆ Some AdminP requests require manual approval by the Notes administrator before they are completed.
- ◆ AdminP requests typically include the FullName of the Notes user (or ListName for a group). The driver sends requests based on the FullName of the user at the time the request was initiated, but AdminP does not necessarily complete the request immediately, and other requests that affect the FullName of the same user object might be waiting to be processed. If the FullName of the user is changed by a request, a subsequent request might fail because AdminP can't find the user.

For example, consider this scenario:

- ◆ You send a request from the driver to change a user's first name in Notes, and you use the AdminP feature to also rename the user object (changing FullName).
- ◆ You immediately send a second request from the driver to change the same user's last name in Notes and also rename the user object (changing FullName).

Both requests are received by AdminP. Both requests refer to the user with the same FullName. At midnight, AdminP begins processing the requests. The first one succeeds. However, the second one fails because the FullName was changed by the first request.

To help you use AdminP effectively, the following features are provided:

- ◆ You can cause the driver to send commands directly to the Domino Console. For example, you can issue a command to process all AdminP requests immediately. See [“TELL AdminP Commands” on page 96](#), and [Domino Console Command](#) in [“Custom Driver Parameters” on page 55](#).
- ◆ You can enable or disable AdminP support for an individual command. See [Allow AdminP Support](#) in [“Custom Driver Parameters” on page 55](#).

TELL AdminP Commands

When the driver issues a request to the Domino AdminP process, these requests are delayed until the AdminP process completes them. (Refer to Notes documentation for information about administration processing intervals.)

If desired, you can attach a `tell-adminp-process` attribute to an event. If the event contains AdminP tasks that need to be performed, the command you specify is sent to the Domino server console. The attribute is described in [Domino Console Command](#) in [“Custom Driver Parameters” on page 55](#).

For example, when sending a Move user event, you could include the following attribute on the move event:

```
tell-adminp-process="tell adminp process new"
```

This example command causes the driver to request the AdminP process to process all the new tasks, which would include the move that was requested in that event.

To use `tell-adminp-process` commands:

- 1 Make sure you have turned on support for the AdminP process by adding the following parameter to the Subscriber Options in the driver parameters:

```
<allow-adminp-support display-name="Allow Domino AdminP Support">True</allow-adminp-support>
```

See [Allow Domino AdminP Support](#) in “Subscriber Options” on page 44.

- 2 Make sure the Notes user for the driver has rights to send commands to the Domino server console.

- 3 Make sure that the event contains AdminP tasks.

The `tell-adminp-process` command is sent only if AdminP tasks need to be performed as part of the event.

- 4 Use the correct syntax.

Samples of using `tell-adminp-process` commands are included in [Appendix D, “Sample XDS Documents for Custom Parameters,”](#) on page 131.

- 5 To find out whether the AdminP request was completed successfully, use Lotus Notes tools such as the Domino Administrator.

Completion of a command by the Notes driver shim involving an AdminP request does not mean that the command has been successfully completed. It means only that the request has been made to AdminP.

For example, the driver might successfully make a request to AdminP to move a user. However, if incorrect certifiers are specified in the event, the move fails when the AdminP process attempts it.

User.id Password Set

The Notes driver shim provides password-set capabilities through the `modify-password` command. When issuing the command on the Subscriber channel, the Notes driver shim uses a shared native library to access the appropriate Lotus Notes APIs that allow for changing a password within a `user.id` file.

The shared native library that comes with the driver is named `notesdrvjni`. On the Windows platform, `notesdrvjni.dll` is placed in the Identity Manager binaries folder (`c:\novell\nds`) where the `NotesDriverShim.jar` can find it when the driver launches. On Linux, the `notesdrvjni.so` file is linked to the Notes/Domino execution directory.

If the Notes driver shim initializes with the `notesdrvjni` shared library present, text similar to the following should show in a level 3 (or above) trace:

```
"NotesDriverShimLotusCAPIAccess: notesdrvjni (notesdrvjni.dll)
successfully loaded."
```

If this text does not appear, or if you see a different message, the feature is automatically disabled within the Notes driver shim.

Upon receiving the `modify-password` command, the Notes driver shim attempts to modify the Notes `user.id` file passwords if the `modify-password` command has the following elements:

- ♦ An old-password
- ♦ A password element
- ♦ A `user-id-file="c:\Lotus\Notes\ids\people\JohnDoe.id"` XML attribute as a custom parameter

This custom parameter is the same as the parameter that is used for add commands, but in this case the specified filename is never used in conjunction with the `user-id-path` parameter because it is with an add command. If a full path is not specified, the Notes driver shim directs the `user.id` file search to the default directory that the driver is using (the `Notes/Domino` data folder).

This `user-id-file` parameter can also be used to specify multiple ID files by separating the ID filenames with semicolons (";"). (such as `user-id`

```
file="ids\people\JohnDoe.id;ids\people\johnnydoe.id;c:\Temp\jd.id".
```

ID files that require multiple passwords cannot be set by using this feature. However, it is possible to use this feature to change the password for a `user.id` file, a `server.id` file, or a `cert.id` file. Below is a general example of an XDS command setting a password for `JohnDoe.id`:

```
<input>
  <modify-password
    class-name="Person"
    event-id="pwd-subscribe"
    src-dn="\PWDSYNCTREE\sync\dom\unit\JohnDoe"
    src-entry-id="35952"
    user-id-file="c:\Lotus\Notes\ids\people\JohnDoe.id">
    <association>D9628831A988381AC12570F9005BE6B3</association>
    <old-password>zyxwvut321</old-password>
    <password>abcdefg123</password>
  </modify-password>
</input>
```

The Notes driver shim must have appropriate read and write file system access to the specified `user.id` file. When a correct `user-id-file="user.id"` XML attribute and valid `<old-password>` and `<password>` elements are available to the `modify-password` command, this command then modifies an existing `user.id` file password, as well as the HTTPPassword within the Notes Address Book (NAB).

You can control whether Notes driver shim modifies the `user.id` password or the HTTPPassword by using the following driver parameters that you set within subscriber-options section of the driver configuration:

```
allow-http-password-set allow-userid-password-set
```

These subscriber-options parameters are Boolean and can be set to True or False, depending on the desired default behavior of the Notes driver shim. They can also be used as override parameters when you set them as attributes to the `<modify-password>` element.

If you only want to modify the HTTPPassword, omit the `user-id-file` attribute from the XDS command, or apply the `allow-userid-password-set="false"` attribute. If you only want to modify the `user.id` password, then apply the `allow-http-password-set="false"` attribute.

ID Vault Support

ID Vault is a server-based database that stores protected copies of Lotus Notes user IDs. ID Vault allows Domino administrators to perform tasks such as recover and reset passwords, recover IDs, and rename users. Users are assigned to an ID Vault through a policy. When the policy takes effect, copies of user IDs are automatically uploaded to the ID Vault.

The Identity Manager driver for Lotus Notes supports the use of ID Vault. By default, the driver packages support connecting to a single ID Vault running locally on a Domino server. Connecting to multiple vaults requires customizing the default configuration using Designer or iManager.

The following examples depict these scenarios:

Example 1: An organization has three different organizational units (OU): Sales, Engineering, and Marketing. The Sales OU uses the sales.nsf vault, the Engineering OU uses the eng.nsf vault, and the Marketing OU uses the marketing.nsf vault. ID Vault and the Domino server on which the names.nsf file resides are on the same server.

In this case, you need to perform the following actions:

1. Add new GCVs to the driver to include the vaults for Sales, Engineering, and Marketing.

```
<definition display-name="Sales organization ID Vault DB Name"
name="account.idVault.salesIDVaultDB" type="string">
  <description>Enter the Sales organization ID Vault database name.</
description>
  <value>sales.nsf</value>
</definition>
<definition display-name="Marketing organization ID Vault DB Name"
name="account.idVault.markIDVaultDB" type="string">
  <description>Enter the Marketing organization ID Vault database
name.</description>
  <value>marketing.nsf</value>
</definition>
<definition display-name="Engineering organization ID Vault DB Name"
name="account.idVault.engIDVaultDB" type="string">
  <description>Enter the Engineering organization ID Vault database
name.</description>
  <value>eng.nsf</value>
</definition>
```

2. Add a policy in the Subscriber Command Transformation policies to instruct the driver to place a userID in a specific vault on the Domino server.

```

<?xml version="1.0" encoding="UTF-8"?>
<policy>
<rule>
  <description>setting the Sales idVault Names</description>
  <conditions>
    <and>
      <if-operation op="equal">delete</if-operation>
      <if-class-name op="equal">User</if-class-name>
      <if-src-dn op="in-subtree"
xml:space="preserve">\~dirxml.auto.treename~\~account.src-
loc.SalesName~</if-src-dn>
      <if-global-variable name="account.idVault.salesIDVaultDB" op="not-
equal"/>
    </and>
  </conditions>
  <actions>
    <do-set-xml-attr expression="../delete[@class-name='User']"
name="IDVault-database">
      <arg-string>
        <token-global-variable name="account.idVault.salesIDVaultDB"/>
      </arg-string>
    </do-set-xml-attr>
  </actions>
</rule>
<rule>
  <description>setting the Marketing idVault Names</description>
  <conditions>
    <and>
      <if-operation op="equal">delete</if-operation>
      <if-class-name op="equal">User</if-class-name>
      <if-src-dn op="in-subtree"
xml:space="preserve">\~dirxml.auto.treename~\~account.src-
loc.MktgName~</if-src-dn>
      <if-global-variable name="account.idVault.markIDVaultDB" op="not-
equal"/>
    </and>
  </conditions>
  <actions>
    <do-set-xml-attr expression="../delete[@class-name='User']"
name="IDVault-database">
      <arg-string>
        <token-global-variable name="account.idVault.markIDVaultDB"/>
      </arg-string>
    </do-set-xml-attr>
  </actions>
</rule>
<rule>
  <description>setting the Engineering idVault Names</description>
  <conditions>
    <and>
      <if-operation op="equal">delete</if-operation>
      <if-class-name op="equal">User</if-class-name>

```

```

    <if-src-dn op="in-subtree"
xml:space="preserve">\~dirxml.auto.treename~\~account.src-
loc.EngName~</if-src-dn>
    <if-global-variable name="account.idVault.engIDVaultDB" op="not-
equal"/>
    </and>
  </conditions>
  <actions>
    <do-set-xml-attr expression="../delete[@class-name='User']"
name="IDVault-database">
    <arg-string>
      <token-global-variable name="account.idVault.engIDVaultDB"/>
    </arg-string>
    </do-set-xml-attr>
  </actions>
</rule>
</policy>

```

Example 2: ID Vault and the Domino server on which the names.nsf file resides are on different servers.

Use `admin-p` in your policy to specify the ID Vault server name from which the user IDs should be either deleted or moved to an inactive state.

```

<?xml version="1.0" encoding="UTF-8"?>
<policy>
<rule>
  <description>setting the Sales idVault Server Names & Database
Names</
description>
  <conditions>
    <and>
      <if-operation op="equal">delete</if-operation>
      <if-class-name op="equal">User</if-class-name>
      <if-src-dn op="in-subtree"
xml:space="preserve">\~dirxml.auto.treename~\~account.src-loc.SalesName~</
if-srcdn>
      <if-global-variable name="account.idVault.salesIDVaultDB" op="not-
equal"/>
      <if-global-variable name="account.idVault.salesIDVaultServerName"
op="notequal"/>
    </and>
  </conditions>
  <actions>
    <do-set-xml-attr expression="../delete[@class-name='User']"
name="IDVaultdatabase">
    <arg-string>
      <token-global-variable name="account.idVault.salesIDVaultDB"/>
    </arg-string>
    </do-set-xml-attr>
    <do-set-xml-attr expression="../delete[@class-name='User']"
name="adminpserver">
    <arg-string>
      <token-global-variable name="account.idVault.salesIDVaultServerName"/>
    </arg-string>
    </do-set-xml-attr>

```

```

</actions>
</rule>
<rule>
  <description>setting the Marketing idVault Server Names & Database
Names</
description>
  <conditions>
    <and>
      <if-operation op="equal">delete</if-operation>
      <if-class-name op="equal">User</if-class-name>
      <if-src-dn op="in-subtree"
xml:space="preserve">\~dirxml.auto.treename~\~account.src-loc.MktgName~</
if-srcdn>
      <if-global-variable name="account.idVault.markIDVaultDB" op="not-
equal"/>
      <if-global-variable name="account.idVault.markIDVaultServerName"
op="notequal"/>
    </and>
  </conditions>
  <actions>
    <do-set-xml-attr expression="../delete[@class-name='User']"
name="IDVaultdatabase">
      <arg-string>
        <token-global-variable name="account.idVault.markIDVaultDB"/>
      </arg-string>
    </do-set-xml-attr>
    <do-set-xml-attr expression="../delete[@class-name='User']"
name="adminpserver">
      <arg-string>
        <token-global-variable name="account.idVault.markIDVaultServerName"/>
      </arg-string>
    </do-set-xml-attr>
  </actions>
</rule>
<rule>
  <description>setting the Engineering idVault Names</description>
  <conditions>
    <and>
      <if-operation op="equal">delete</if-operation>
      <if-class-name op="equal">User</if-class-name>
      <if-src-dn op="in-subtree"
xml:space="preserve">\~dirxml.auto.treename~\~account.src-loc.EngName~</
if-src-dn>
      <if-global-variable name="account.idVault.engIDVaultDB" op="not-equal"/>
      <if-global-variable name="account.idVault.engIDVaultServerName"
op="notequal"/>
    </and>
  </conditions>
  <actions>
    <do-set-xml-attr expression="../delete[@class-name='User']"

```

```
name="IDVaultdatabase">
  <arg-string>
    <token-global-variable name="account.idVault.engIDVaultDB"/>
  </arg-string>
</do-set-xml-attr>
<do-set-xml-attr expression=" ../delete[@class-name='User']"
name="adminpserver">
  <arg-string>
    <token-global-variable name="account.idVault.engIDVaultServerName"/>
  </arg-string>
</do-set-xml-attr>
</actions>
</rule>
</policy>
```

6 Managing the Driver

As you work with the Lotus Notes driver, there are a variety of management tasks you might need to perform, including the following:

- ◆ Starting, stopping, and restarting the driver
- ◆ Viewing driver version information
- ◆ Using Named Passwords to securely store passwords associated with the driver
- ◆ Monitoring the driver's health status
- ◆ Backing up the driver
- ◆ Inspecting the driver's cache files
- ◆ Viewing the driver's statistics
- ◆ Using the DirXML Command Line utility to perform management tasks through scripts
- ◆ Securing the driver and its information
- ◆ Synchronizing objects
- ◆ Migrating and resynchronizing data
- ◆ Activating the driver

Because these tasks, as well as several others, are common to all Identity Manager drivers, they are included in one reference, the [NetIQ Identity Manager Driver Administration Guide](#).

7 Troubleshooting the Driver

This section contains potential problems and error codes you might encounter while configuring or using the driver.

- ♦ [“Troubleshooting Driver Processes” on page 107](#)
- ♦ [“Troubleshooting Lotus Notes-Specific Items” on page 107](#)

Troubleshooting Driver Processes

Viewing driver processes is necessary to analyze unexpected behavior. To view the driver processing events, use DSTrace. You should only use it during testing and troubleshooting the driver. Running DSTrace while the drivers are in production increases the utilization on the Identity Manager server and can cause events to process very slowly. For more information, see [“Viewing Identity Manager Processes”](#) in the *NetIQ Identity Manager Driver Administration Guide*.

Troubleshooting Lotus Notes-Specific Items

- ♦ [“Creating Lotus Notes Accounts and Groups” on page 107](#)
- ♦ [“Troubleshooting Installation Problems” on page 108](#)
- ♦ [“Driver Issues” on page 109](#)

Creating Lotus Notes Accounts and Groups

Use the following procedure to create a Notes User ID to be used exclusively by the driver, if you are having problems getting accounts created.

- 1 Create a Notes User ID to be used exclusively by the driver and give it manager-level ACL access to the target Notes database (usually `names.nsf`), the output database (`ndsrep.nsf`) created by `ndsrep`, and `certlog.nsf`. If you are synchronizing with the `names.nsf` database, you should select (turn on) all ACL roles (GroupCreator, GroupModifier, NetCreator, NetModifier, PolicyCreator, PolicyModifier, PolicyReader, ServerCreator, ServerModifier, UserCreator, UserModifier).
- 2 If a Deny Access group doesn't already exist, create this group by using the Lotus Domino Administrator tool. This group is used to hold disabled user accounts.
- 3 (Optional) Copy and save the Universal ID (UNID) for the Deny Access group you just created. This string is used by the driver to uniquely identify this object, and you need to specify it when you are importing the driver configuration.
To get the string:
 - 3a View the Document Properties of the group. (You can select the object and right-click to select Document Properties.)
 - 3b Click the **Meta** tab (the fifth tab from the right).

- 3c** Go to the end of the text in the `Identifier` field, and copy the character string from the last forward slash to the end. This is always 32 alphanumeric characters.

For example, if text in the `Identifier` field is `Notes://myserver/87256E530082B5F4/85255E01001356A8852554C200753106/16A28402CCEB7A9C87256E9F007EDA9B` then the UNID would be `16A28402CCEB7A9C87256E9F007EDA9B`

- 3d** Paste this information into a file for later use when you run the Create Driver Wizard, as noted in [“Creating the Driver Object in Designer” on page 24](#).

Troubleshooting Installation Problems

- ♦ [“Windows” on page 108](#)
- ♦ [“Linux” on page 108](#)

Windows

The first time the driver runs, it searches for the Domino server (specified in the driver parameters at import time), and tries to open `dsrepcfg.nsf` to write the publisher parameters that `ndsrep` reads. If `dsrepcfg.nsf` does not exist, the Notes driver shim attempts to create `dsrepcfg.nsf` using the database template `dsrepcfg.ntf` that ships with the driver.

If `dsrepcfg.nsf` is successfully created, and contains data specifying an appropriate update database file (usually named `ndsrep.nsf`), then you can load `ndsrep` successfully at the Domino Console.

If `dsrepcfg.ntf` is not found, or this initial `dsrepcfg.nsf` creation process fails, then the Publisher channel shuts down, and you can't load the `ndsrep` task at the Domino console.

You can use a Notes Client to create the `dsrepcfg.nsf` database by using the `dsrepcfg.ntf` template. After doing so, modify the ACL so that the Notes driver user has manager-level access to the database.

Linux

If you upgrade the Notes Client after installing the driver, you need to do one of the following:

- ♦ [“Check and Re-Create Links” on page 108](#)
- ♦ [“Reinstall the Driver” on page 109](#)
- ♦ [“Check the Trace Log” on page 109](#)

Check and Re-Create Links

Check the symbolic links, and re-create them manually if necessary. Use [Table 7-1 on page 109](#) if your Domino server is V8.x or later running eDirectory 8.8.x.

Table 7-1 Links to Check for Domino V8.x or later with eDirectory 8.8.x

File to Link	Symbolic Link to Create
Notes.jar	<pre>/opt/novell/eDirectory/lib/dirxml/classes/Notes.jar</pre> <p>Example:</p> <pre>ln -s /opt/ibm/../../jvm/lib/ext/Notes.jar /opt/novell/eDirectory/lib/dirxml/classes/Notes.jar</pre>
libnotesdrvjni.so	<pre>/opt/ibm/./notes/libnotesdrvjni.so.1.0.0</pre> <p>Example:</p> <pre>cp /opt/novell/eDirectory/lib/dirxml/rules/notes/libnotesdrvjni.so.1.0.0 /opt/ibm/./notes/libnotesdrvjni.so.1.0.0</pre> <pre>ln -s /opt/ibm/./notes/libnotesdrvjni.so.1.0.0 /opt/ibm/./notes/libnotesdrvjni.so.1</pre> <pre>ln -s /opt/ibm/./notes/libnotesdrvjni.so.1.0.0 /opt/ibm/./notes/libnotesdrvjni.so</pre>

Reinstall the Driver

Back up the files listed below, then reinstall the driver. Reinstalling the driver shim re-creates the symbolic links, but it overwrites certain files. If you have made changes to them, you need to make a backup.

Back up the following files:

- ♦ `rdxml.startnotes`
- ♦ `rdxml.stopnotes`
- ♦ `findDomino`
- ♦ `rdxml.confignotes` (or wherever your configuration is stored)

After reinstalling the driver shim, copy the backups to their original location.

Check the Trace Log

The sample scripts provided (`rdxml.startnotes`, `rdxml.stopnotes`, `findDomino`) produce a Remote Loader trace log for the driver that can be used for troubleshooting.

Driver Issues

- ♦ [“Driver Might Fail to Connect to the Domino Server” on page 110](#)
- ♦ [“Unable to Start the Driver as a Service on Windows 7” on page 110](#)

Driver Might Fail to Connect to the Domino Server

If you encounter this issue, follow these steps to resolve it:

- 1 Install the Domino Administrator.
- 2 Connect to the Domino server.
- 3 Start the driver.

Unable to Start the Driver as a Service on Windows 7

To start the driver as a service, configure the Remote Loader with the administrative privileges before running it.

- 1 Right-click the Remote Loader shortcut icon.
- 2 In the menu that displays, select **Run as administrator**.

Alternatively, click Ctrl+Shift+Click keys from the keyboard.

To stop or edit the driver service, run the Remote Console utility as an administrator.

A Driver Properties

This section provides information about the Driver Configuration and Global Configuration Values properties for the Lotus Notes driver. These are the only unique properties for drivers. All other driver properties (Named Password, Engine Control Values, Log Level, and so forth) are common to all drivers. Refer to “[Driver Properties](#)” in the *NetIQ Identity Manager Driver Administration Guide* for information about the common properties.

The information is presented from the viewpoint of iManager. If a field is different in Designer, it is marked with a Designer icon.

- ♦ “[Driver Configuration](#)” on page 111
- ♦ “[Global Configuration Values](#)” on page 116

Driver Configuration

In iManager:

- 1 Click  to display the Identity Manager Administration page.
- 2 Open the driver set that contains the driver whose properties you want to edit:
 - 2a In the **Administration** list, click **Identity Manager Overview**.
 - 2b If the driver set is not listed on the **Driver Sets** tab, use the **Search In** field to search for and display the driver set.
 - 2c Click the driver set to open the Driver Set Overview page.
- 3 Locate the driver icon, then click the upper right corner of the driver icon to display the **Actions** menu.
- 4 Click **Edit Properties** to display the driver’s properties page.

By default, the Driver Configuration page is displayed.

In Designer:

- 1 Open a project in the Modeler.
- 2 Right-click the driver icon or line, then select click **Properties > Driver Configuration**.

The Driver Configuration options are divided into the following sections:

- ♦ “[Driver Module](#)” on page 112
- ♦ “[Driver Object Password](#)” on page 112
- ♦ “[Authentication](#)” on page 112
- ♦ “[Startup Option](#)” on page 113
- ♦ “[Driver Parameters](#)” on page 113
- ♦ “[ECMAScript](#)” on page 116
- ♦ “[Global Configuration](#)” on page 116

Driver Module

The driver module changes the driver from running locally to running remotely or the reverse.

Java: Used to specify the name of the Java class that is instantiated for the shim component of the driver. This class can be located in the `classes` directory as a class file, or in the `lib` directory as a `.jar` file. If this option is selected, the driver is running locally.

The java class name is:

```
com.novell.nds.dirxml.driver.notes.NotesDriverShim
```

Native: This option is not used with the Lotus Notes driver.

Connect to Remote Loader: Used when the driver is connecting remotely to the connected system. Designer includes two suboptions:

- ♦ **Remote Loader Client Configuration for Documentation:** Includes information on the Remote Loader client configuration when Designer generates documentation for the driver.
- ♦ **Driver Object Password:** Specifies a password for the Driver object. If you are using the Remote Loader, you must enter a password on this page. Otherwise, the remote driver does not run. The Remote Loader uses this password to authenticate itself to the remote driver shim.

Driver Object Password

Driver Object Password: Use this option to set a password for the driver object. If you are using the Remote Loader, you must enter a password on this page or the remote driver does not run. This password is used by the Remote Loader to authenticate itself to the remote driver shim.

Authentication

The Authentication section stores the information required to authenticate to the connected system.

User ID: Specify a user application ID. This ID is used to pass Identity Vault subscription information to the application.

Example: `CN=NotesDriver/o=novell`

Connection Information: Specify the IP address or name of the server the application shim should communicate with.

The connection string uses the following format: `CN=DominoServer1/o=novell`

Remote Loader Connection Parameters: Used only if the driver is connecting to the application through the Remote Loader. The parameter to enter is `hostname=xxx.xxx.xxx.xxx port=xxxx kmo=certificatename`, where the hostname is the IP address of the application server running the Remote Loader server and the port is the port the Remote Loader is listening on. The default port for the Remote Loader is 8090.

The `kmo` entry is optional. It is only used when there is an SSL connection between the Remote Loader and the Identity Manager engine.

Example: `hostname=10.0.0.1 port=8090 kmo=IDMCertificate`

Application Password: Specify the password for the user object listed in the **Authentication ID** field.

Remote Loader Password: Used only if the driver is connecting to the application through the Remote Loader. The password is used to control access to the Remote Loader instance. It must be the same password specified during the configuration of the Remote Loader on the connected system.

Cache limit (KB): Specify the maximum event cache file size (in KB). If it is set to zero, the file size is unlimited.

Click **Unlimited** to set the file size to unlimited in Designer.

Startup Option

The Startup Option section allows you to set the driver state when the Identity Manager server is started.

Auto start: The driver starts every time the Identity Manager server is started.

Manual: The driver does not start when the Identity Manager server is started. The driver must be started through Designer or iManager.

Disabled: The driver has a cache file that stores all of the events. When the driver is set to Disabled, this file is deleted and no new events are stored in the file until the driver state is changed to Manual or Auto Start.

Do not automatically synchronize the driver: This option only applies if the driver is deployed and was previously disabled. If this is not selected, the driver re-synchronizes the next time it is started.

Driver Parameters

The Driver Parameters section lets you configure the driver-specific parameters. When you change driver parameters, you tune driver behavior to align with your network environment.

The parameters are presented by category:

- ♦ [“Driver Options” on page 113](#)
- ♦ [“Subscriber Settings” on page 114](#)
- ♦ [“Publisher Options” on page 115](#)

Driver Options

Notes Domain Name: Specify the name of the Notes Domain. An example is **NotesDomain**.

Notes Driver User ID File: Specify the full path of the Notes User ID file located on the Lotus Notes client workstation. The Notes User ID file contains details about the Notes user that the driver will use for authenticating with Lotus Notes. For example `c:\lotus\notes\data\admin.id`.

Default Certifier ID File: Specify the full path of the Default Notes Certifier ID file located on the Lotus Notes client workstation that the driver will use as the default certifier. This is usually the root certifier, but it can be any certifier with adequate access. For example `c:\lotus\notes\data\cert.id`.

Default Certifier Password: Specify the password for the Default Notes Certifier ID this driver will use when certifying new users, then reconfirm the password. You can also clear the password.

This password is secured by using the Named Passwords feature. See [“Using Named Passwords” on page 40](#).

Directory File: The Notes database filename that the Notes Driver is synchronizing. For example, `names.nsf` is the Notes public address book.

Notes Address Book: Select **True** if the Notes database that is being synchronized is a Notes Address Book. Select **False** if the Notes database that is being synchronized is not a Notes Address Book.

Update File: The `ndsrep` program creates an output database (by default, `ndsrep.nsf`), detects changes in the address book in the Domino server (or other Notes database), and copies these changes to the output database. The default filename is `ndsrep.nsf`.

Enable Cache: Select **True** to cache the UNIDs for the group membership related operations. It is recommended to use cache for large databases with very slow response time. Select **False** to disable the cache functionality. The default is **False**.

Cache Refresh Interval: Specify the refresh interval time in minutes. The default value is 60 minutes. The driver refreshes the cache when the interval between the last group-related operation and the most recent operation exceeds the cache refresh duration that you specified during driver configuration. The driver does not refresh the cache if there are frequent updates to the Group membership in the database.

Subscriber Settings

Certify (register) Notes Users: Select whether the driver should certify users added to Notes on the Subscriber channel. The following options are displayed only if you select **True**.

- ◆ **Registration/Certification Log File:** The Certification log file of the Domino server (`certlog.nsf`). For the Notes driver to register or certify Notes users, the Notes driver user must have rights to create entries in this database.
- ◆ **Default User ID File/Registration Expiration Term (in years):** Specify the expiration term (in years) for ID files created by the driver when certifying users added on the Subscriber channel. The default is 2.
- ◆ **User ID File Storage Location:** The full directory path of the location to create UserID files for newly created users.
- ◆ **Add Registered Users to Address Book:** Select **True** if you want to add newly registered users in the Notes Address Book. Select **False** so newly registered users who have a UserID file created are not placed in the Notes Address Book.
- ◆ **Store User ID File in Address Book:** Whether Notes should store new user IDs in the address book when certifying users added to Notes on the Subscriber channel. The default is **False**.
- ◆ **Is Domino Server North American?:** Whether the Domino server this driver is binding to when certifying new users a North American Domino server. (This affects encryption levels.) Choose **True** for 128-bit encryption. The default is **True**.
- ◆ **Notes Password Strength (0-16):** Specify the minimum password strength for new Notes user IDs (0 - 16). The default is 5.

- ◆ **Specify User Key Strength:** By default, the driver uses the key strength from the Domino server to encrypt the UserID file. To use a different key strength, change the setting to **True**. The driver displays **User Key Strength** option to set the strength of the key.
- ◆ **User Key Strength:** Specify the key strength for the driver to use. The options are:
 - ◆ 630 Bits (default)
 - ◆ 1024 Bits
 - ◆ 2048 Bits

Create User E-Mail Box: Select **True** if you want to create a Notes e-mail account for users. Select **False** if you do not want to create an e-mail account for users. The default is **True**.

- ◆ **Domino Mail Server Name:** Specify the name of the Domino mail server this driver will authenticate to (in fully qualified canonical form, such as `cn=MyMailServer/o=Organization`).
- ◆ **Mail File Template:** Specify the filename (on the Domino server) for the mail database template this driver will use when creating new mail file users. The path should be relative to the Domino mail server's data directory.

The name of the template corresponds to the Domino version: `mail8.ntf`, `mail85.ntf`, or `mail9.ntf`.
- ◆ **User Mail File Storage Location:** Specify the directory where you want to store user mail files. An example value is `mail`.

Default Notes Password: Specify the default password for newly registered users if no other password is supplied to the Notes driver shim. An example value is `notes`.

Default HTTP Password: Specify the default Notes Web HTTP password for new Notes users if no other password is supplied to the Notes driver shim. An example value is `notes`.

ID Vault Support: Select whether to use ID Vault support. Domino version 8.5 added ID Vault support to store ID files in a separate database.

- ◆ **ID Vault database file name:** Specify the ID Vault database file.
- ◆ **Mark deleted users as inactive in ID Vault:** Select whether you want to mark deleted users' ID files as inactive in the ID Vault database.

Publisher Options

Polling Interval (in seconds): Specify the polling interval (in seconds) for how often the Publisher channel checks the change log for updates. The default is **30**.

Enable Loop Back Detection: Select **True** to enable event loopback capability, or **False** to disable event loopback detection. Loopbacks cannot be used to determine object changes if they are performed by the Administration Process (AdminP). The default is **True**.

NDSREP Polling Units: The units of time used to specify the ndsrep polling interval. You can specify **Seconds**, **Minutes**, **Hours**, **Days**, or **Years**. The default is **Seconds**.

NDSREP Polling Interval: A positive integer specifying the polling interval for ndsrep. The default value is **30**.

DN Format: Specify the distinguished name format used by the Publisher channel. Changing this parameter might also necessitate changing the Publisher Placement policy where the Notes Source DN is often interpreted to determine Identity Vault object placement.

The choices are **NOTES_TYPED**, **NOTES**, **SLASH_TYPED**, **SLASH**, **LDAP_TYPE**, **LDAP**, **DOT_TYPED**, and **DOT**. The default is **SLASH**.

NDSREP Domino Console Trace Level: Specify the Domino console trace setting. The choices are **Silent**, **Normal**, **Verbose**, and **Debug**. The default is **Normal**.

Check Attributes: Whether all attributes should be checked for each object event. Select **True** for only changed attribute values to be published from Notes to Identity Manager. Select **False** for all attributes within the Publisher channel filter to be published from Notes to Identity Manager if a changed attribute is detected. The default is **True**.

Write Time Stamps: Whether driver time stamps should be written to each synchronized object. Select **True** to attach a Notes driver-specific time stamp to each object that the Notes driver modifies. This action is done to improve the driver's ability to detect object changes from replicated databases. Select **False** to disallow any special time stamps from being attached to Notes objects. The default is **False**.

Publisher heartbeat interval: Allows the driver to send a periodic status message on the Publisher channel when there has been no Publisher channel traffic for the given number of seconds.

The default value is 1 second.

ECMAScript

Displays an ordered list of ECMAScript resource files. The files contain extension functions for the driver that Identity Manager loads when the driver starts. You can add additional files, remove existing files, or change the order the files are executed.

Global Configuration

Displays an ordered list of Global Configuration objects. The objects contain extension GCV definitions for the driver that Identity Manager loads when the driver is started. You can add or remove the Global Configuration objects, and you can change the order in which the objects are executed.

Global Configuration Values

Global configuration values (GCVs) are values that can be used by the driver to control functionality. GCVs are defined on the driver or on the driver set. Driver set GCVs can be used by all drivers in the driver set. Driver GCVs can be used only by the driver on which they are defined.

The Lotus Notes driver includes many GCVs. You can also add your own if you discover you need additional ones as you implement policies in the driver.

To access the driver's GCVs in iManager:

- 1 Click  to display the Identity Manager Administration page.

- 2 Open the driver set that contains the driver whose properties you want to edit.
 - 2a In the **Administration** list, click **Identity Manager Overview**.
 - 2b If the driver set is not listed on the **Driver Sets** tab, use the **Search In** field to search for and display the driver set.
 - 2c Click the driver set to open the Driver Set Overview page.
- 3 Locate the driver icon, click the upper right corner of the driver icon to display the **Actions** menu, then click **Edit Properties**.

or

To add a GCV to the driver set, click **Driver Set**, then click **Edit Driver Set properties**.

To access the driver's GCVs in Designer:

- 1 Open a project in the Modeler.
- 2 Right-click the driver icon  or line, then select **Properties > Global Configuration Values**.

or

To add a GCV to the driver set, right-click the driver set icon , then click **Properties > GCVs**.

The global configuration values are organized as follows:

- ♦ ["Configuration" on page 117](#)
- ♦ ["Wild Card Search Option" on page 121](#)
- ♦ ["Entitlements" on page 121](#)
- ♦ ["Password Synchronization" on page 122](#)
- ♦ ["Account Status Support" on page 123](#)
- ♦ ["Account Tracking" on page 123](#)

Configuration

There multiple configuration sections for the Notes driver:

- ♦ ["Certifier Options" on page 117](#)
- ♦ ["New User Options" on page 118](#)
- ♦ ["E-Mail Options" on page 119](#)
- ♦ ["Domino Administration Process Activation Command Options" on page 120](#)

Certifier Options

Show Certifier Options: Select **show** to display the certifier options.

Fully Qualified Default Certifier Name: Specify the default Fully Qualified (typed) Notes Certifier name as found in the Notes Address Book. The root certifier can be used (an example is `/o=acme`).

Default Certifier Name: Specify the default Notes Certifier name as found in the Notes Address Book. The root certifier can be used (an example is `/acme`).

Default Certifier Driver Parameter Key: Specify the driver parameter key name that stores the default certifier ID file name. An example is `cert-id-file`.

Default Certifier Password Driver Parameter Key: Specify the driver parameter key name that stores the default certifier ID password. An example is `cert-id-password`.

New User Options

Show New User Options: Select **show** to display the new user options.

Notes User Certification Options: Select the desired Notes User Certification option. Select **True** to create a Notes Certification ID file for the user. Select **False** to not create the Notes Certification ID file. The default is **True**.

User ID File Creation: Select the desired Notes User ID file creation option. Select **True** to create an ID file when registering users. Select **False** to not create the ID file. The default is **True**.

- ♦ **Store user ID File in Address book:** Select the desired Notes User ID file option. Select **True** to place a Notes Certification ID file for the user in the Notes address book. Select **False** to not place the Notes Certification ID file in the address book. The default is **False**.

User ID Expire Term (in years): Specify the expiration term (in years) for ID files created by the driver when certifying users who are added on the Subscriber channel. This number specifies how many years the user's Certification ID file will be valid. The default is **2**.

User ID Expiration Date: Specify an expiration date, or leave the field blank to ignore this setting. Specify the date when the user's Certification ID file will expire. This entry has priority over the Expire Term entry.

Alternate Organization Unit: Specify an alternate Organizational Unit to be used for each registered user, or leave the field blank to ignore this setting.

Alternate Organization Unit Language: Specify an alternate Organizational Unit language to be used for each registered user, or leave the field blank to ignore this setting.

Notes Explicit Policy Name to be attached to User: Specify the desired Notes Explicit Policy Name to be attached to each registered user. When specified, registration policies are not executed.

Synchronize User's Internet Password: Select the user's Internet password option. Select **True** to synchronize the user password with the Web password. Select **False** to not synchronize user passwords. The default is **True**.

Notes User Password Check Setting: Select **Default** to ignore this setting. Select **Check Password** to require users to enter a password when authenticating to servers that have password checking enabled. Select **Don't Check** to not require users to enter a password when authenticating to other servers. Select **Lockout** to prevent users from accessing servers that have password checking enabled. The default is **Check Password**.

Notes User Password Change Interval (in days): Specify the desired user password change interval in days. Specify a number to indicate the days a password is valid and before the user must supply a new password.

Notes User Password Grace Period (in days): Specify the desired user password grace period in days. Specify a number to indicate the days the grace period is valid before the user must supply a new password.

Notes User Internet Password Change Required: Select the user's Internet password change option. Select **True** to require users to change the password on the next login. Select **False** to not require users to change the password on the next login. The default is **False**.

Roaming Option: Select the desired Notes roaming user option. Select **True** to enable roaming for Notes users. Select **False** to disable roaming. The default is **False**. Selecting **True** brings up the next four options.

- ♦ **Roam Server Name:** Specify the Domino server that will host this roaming user. An example is (cn=ServerName/o=org)
- ♦ **Roam Server Subdirectory:** Specify the Domino server subdirectory to store roaming user data. An example is Roaming\
- ♦ **Cleanup Setting:** Select the Notes roaming user cleanup setting. Select **Default** to do nothing. Select **Never** to never delete roaming data. Select **Every n Days** to delete roaming data by the days specified by **Roaming Cleanup Period**. Select **At Shutdown** to delete Notes data when Notes shuts down. Select **User Prompt** to clean up roaming data when the user exits Notes; the user can also decline to be prompted in the future.
- ♦ **Cleanup Period (in days):** If **Every n Days** is selected as the **Roaming User Cleanup Setting**, specify the number of days before deleting roaming user data.

E-Mail Options

Show E-Mail Options: Select **show** to display the e-mail options.

Internet Mail Domain: Specify the Internet Mail Domain to be used when generating Internet e-mail addresses. An example is **mycompany.com**.

Add User E-Mail Box: Select the desired Notes user e-mail creation option. Select **True** to create a Notes e-mail account for a user. Select **False** to not create an e-mail account. The default is **True**.

- ♦ **Create Mail File in background via AdminP:** Select the desired Notes user e-mail creation option. Select **True** to create a mail file by issuing a request to the Domino administration process to create the mail file in the background through AdminP. Select **False** to create the mail file directly. AdminP support is required for this option. The default is **False**.
- ♦ **Inherit from Mail File Template:** Select the desired Notes user e-mail database inheritance option. Select **True** in order for the user e-mail database to inherit changes from the specified creation template. Select **False** to not inherit changes. You specify the e-mail creation template through the Subscriber channel settings. The default is **True**.
- ♦ **E-Mail Database ACL Setting:** Select the desired Notes user e-mail database ACL option. Select **Default** to ignore this setting. Other options include **Manager, Designer, Author, Editor, Reader, Depositor,** and **No Access**. The default is **Default**.
- ♦ **Mail ACL Manager:** Specify the Notes e-mail database Manager name. Leave this entry blank to allow e-mail access by the owner. If ACL access of the mail database is less than **Manager**, you need to specify an e-mail manager. Use the plus icon to add names, the minus icon to delete names, and the pen icon to edit existing entries.
- ♦ **Mail File Size Quota (in megabytes):** Specify the Notes e-mail database size quota in megabytes. Leave the field blank to ignore this setting. The size specifies disk space that the server administrator allows for the e-mail database. If the Notes driver user is not a Domino server administrator, leave this value blank.

- ♦ **Mail File Size Warning Threshold (in megabytes):** Specify the mail file size warning threshold in kilobytes. Leave the field blank to ignore this setting. The size specifies disk space allowed before warning messages are sent to the database owner.
- ♦ **Mail File Replication:** Select the desired Notes user e-mail file replication option. Select **True** to replicate the mail file of a user. Select **False** to not replicate the mail file. The default is **False**.
 - ♦ **Create Mail File Replica On Which Server:** Specify the distinguished name of the desired Domino server where the mailbox replicas are initially created and should be replicated (for example CN=Server1/O=acme).
 - ♦ **Mail File Replication Priority:** Select the mail file replication priority setting: Low, Medium, or High. The default is Medium.
 - ♦ **Create Mail File Replica in background via AdminP:** Select the desired Notes User E-Mail replica creation option. **True** replicates the mail file by issuing a request to the Administration Process to create the replica in the background. **False** creates the replica directly on the destination server.

NOTE: If the Create Mail File in the account.email.createinbackground (background setting) is set to **True**, the policy overrides this setting with a value of **True**.

- ♦ **User Delete Mail File Action:** Select the action that is taken when a user is deleted.
 - ♦ **All:** Removes the e-mail from the home mail server on all replica mail servers when this user account is deleted.
 - ♦ **Home:** Removes the e-mail only from the home mail server when this user account is deleted.
 - ♦ **None:** Preserves all e-mails when this user account is deleted.

Domino Administration Process Activation Command Options

Show AdminP Options: Select **show** to display the AdminP options.

Tell AdminP Process Command when a User is Added: Select the `AdminP process` command to use when a user is added. This specifies the `Tell adminp Process` command to send to the Domino server immediately after the user has been added to the Domino Public Address Book. Options include **No Action** (default), **All**, **New**, **Daily**, **Delayed**, **Interval**, **People**, and **Time**.

Tell AdminP Process Command when a User is Modified: Select the `AdminP process` command to use when a user is modified. This specifies the `Tell adminp Process` command to send to the Domino server immediately after the user has been modified using AdminP methods in the Domino Public Address Book. Options include **No Action** (default), **All**, **New**, **Daily**, **Delayed**, **Interval**, **People**, and **Time**.

Tell AdminP Process Command when a User is Deleted: Select the `adminp process` command to immediately send to the Domino server after an object is deleted from the Domino Public Address Book. Options include **No Action** (default), **All**, **New**, **Daily**, **Delayed**, **Interval**, **People**, and **Time**.

Remove User or Group object from the Notes Address Book Immediately: Select whether to immediately delete the user or group object from the Notes address book. Select **True** to remove the user or group immediately from the Notes address book. Select **False** to remove the user or group from the Notes address book through the normal course of the background administration process.

Wild Card Search Option

Enable Wild Card Search

Under **Wildcard Search Options (Driver->Edit Properties->Global Config Values ->Configuration)**, if the value of **Enable Wildcard Search** is set to “True”, the driver performs Wildcard search. Else, irrespective of whether the Notes database is Full Text Indexed or not, the driver performs standard search techniques. By default the value of **Global Configuration Value for Enable Wildcard Search** is set to “True”.

Entitlements

Entitlements act like an On/Off switch to control the account access. When the driver is enabled for entitlements, accounts are only created and removed or disabled when the account entitlement is granted to or revoked from the users. For more information, see the [NetIQ Identity Manager Entitlements Guide](#).

The entitlements are divided into the following categories:

- ♦ “Entitlements Options” on page 121
- ♦ “Data Collection” on page 121
- ♦ “Role Mapping” on page 122
- ♦ “Resource Mapping” on page 122
- ♦ “Parameter Format” on page 122
- ♦ “Entitlement Extensions” on page 122

Entitlements Options

Use Account Entitlement: Select **True** to enable the driver to manage Notes accounts based on the driver’s defined entitlements.

- ♦ **When Account Entitlement Revoked:** If the **Use Account Entitlement** option is **True**, specify what action is taken in Notes when a User Account Entitlement is revoked.

User Group Entitlement: Select whether the driver manages groups with the group entitlement. **True** allows the driver to manage Notes groups based on the notesGroup2 Entitlement. **False** does not allow the driver to manage Notes groups based on the notesGroup2Entitlement.

Advance Settings: Select show to display the entitlement options that allow or deny additional functionality like data collection. These settings should rarely be changed.

Data Collection

Data collection enables the Identity Report Module to gather information to generate reports. For more information, see the [Administrator Guide to NetIQ Identity Reporting](#).

Enable data collection: Select **Yes** to enable data collection for the driver through the Data Collection Service by the Managed System Gateway driver. If you are not going to run reports on data collected by this driver, select **No**.

Allow data collection from user accounts: Select **Yes** to allow data collection by the Data Collection Service through the Managed System Gateway driver for the user accounts.

Allow data collection from groups: Select **Yes** to allow data collection by the Data Collection Service through the Managed System Gateway driver for groups.

Role Mapping

Identity Applications allow you to map business roles with IT roles.

Enable role mapping: Select **Yes** to make this driver visible to the Catalog Administrator

Allow mapping of user accounts: Select **Yes** if you want to allow mapping of user accounts in Identity Applications. An account is required before a role, profile, or license can be granted through Identity Applications.

Allow mapping of groups: Select **Yes** if you want to allow mapping of groups in the Catalog Administrator.

Resource Mapping

Identity Applications allow you to map resources to users. For more information, see the [NetIQ Identity Manager - Administrator's Guide to the Identity Applications](#).

Enables resource mapping: Select **Yes** to make this driver visible to Identity Applications.

Allow mapping of user accounts: Select **Yes** if you want to allow mapping of user accounts in Identity Applications. An account is required before a role, profile, or license can be granted.

Allow mapping of groups: Select **Yes** if you want to allow mapping of groups in Identity Applications.

Parameter Format

Format for Account entitlement: Select the parameter format the entitlement agent must use when granting this entitlement. The options are **Identity Manager 4** or **Legacy**.

Format for Group entitlement: Select the parameter format the entitlement agent must use when granting this entitlement. The options are **Identity Manager 4** or **Legacy**.

Entitlement Extensions

User account extensions: The content of this field is added below the entitlement elements in the EntitlementConfiguration resource object.

Group extensions: The content of this field is added below the entitlement element in the EntitlementConfiguration resource object.

Password Synchronization

These GCVs enable password synchronization between the Identity Vault and the Notes system.

In Designer, you must click the  icon next to a GCV to edit it. This displays the Password Synchronization Options dialog box for a better view of the relationship between the different GCVs.

In iManager, to edit the Password management options go to **Driver Properties > Global Configuration Values**, and then edit it in your Password synchronization policy tab.

For more information about how to use the Password Management GCVs, see “[Configuring Password Flow](#)” in the *NetIQ Identity Manager Password Management Guide*.

Connected System or Driver Name: Specify the name of the LDAP system or the driver name. This value is used by the e-mail notification template to identify the source of the notification message.

Application accepts passwords from Identity Manager: If **True**, allows passwords to flow from the Identity Manager data store to the connected system.

Identity Manager accepts passwords from application: If **True**, allows passwords to flow from the connected system to Identity Manager.

Publish passwords to NDS password: Use the password from the connected system to set the non-reversible NDS password in Identity Vault.

Publish passwords to Distribution Password: Use the password from the connected system to set the NMAS Distribution Password used for Identity Manager password synchronization.

Require password policy validation before publishing passwords: If **True**, applies NMAS password policies during publish password operations. The password is not written to the data store if it does not comply.

Reset user’s external system password to the Identity Manager password on failure: If **True**, on a publish Distribution Password failure, attempts to reset the password in the connected system by using the Distribution Password from the Identity Manager data store.

Notify the user of password synchronization failure via e-mail: If **True**, notifies the user by e-mail of any password synchronization failures.

Account Status Support

Use Deny Access Group for Account Status: Select whether to place disabled user accounts into a Notes Deny Access Group.

- ◆ **Deny Access Group Name:** Specify the Notes Deny Access Group where the driver places users when the user account is disabled.

Add Deleted Users to Deny Access Group: Select whether to add the deleted user name into the Deny Access group. Because user deletion does not happen instantaneously in Notes, this option adds more security. Users pending deletion cannot log in even though their accounts are still available in Notes.

Publish Events for Deny Access Group: Select whether to publish events for the Deny Access group or not. Select **Yes** only if you intend to synchronize the Deny Access group.

Account Tracking

Account tracking is part of Identity Reporting. For more information, see the [Administrator Guide to NetIQ Identity Reporting](#).

Enable account tracking: Set this to **True** to enable account tracking policies. Set it to **False** if you do not want to execute account tracking policies.

Realm: Specify the name of the realm, security domain, or namespace in which the account name is unique.

Advanced settings Select **show** to display the account tracking settings. Changing these settings might result in malfunction of the Account Tracking feature. Change these settings only if you know exactly what you are doing.

Identifiers: Add the account identifier attributes. Attribute names must be in the application namespace.

Object Class: Add the object class to track. Class names must be in the application namespace.

Status attribute: Name of the attribute in the application namespace to represent the account status.

Status active value: Value of the status attribute that represents an active state.

Status inactive value: Value of the status attribute that represents an inactive state.

Subscription default status: Select the default status the policies assume when an object is subscribed to the application and the status attribute is not set in the Identity Vault.

Publication default status: Select the default status the policies assume when an object is published to the Identity Vault and the status attribute is not set in the application.

B Trace Levels

The driver supports the following trace levels:

Table B-1 *Supported Trace Levels*

Level	Description
0	No debugging
1-3	Identity Manager messages. Higher trace levels provide more detail.
4	Informational messages about the application
4-5	Previous level plus driver parameters, Remote Loader, driver shim, and driver connection messages.
6	Previous level plus driver status log, schema details, and attribute tracing

For information about setting driver trace levels, see [“Viewing Identity Manager Processes”](#) in the *NetIQ Identity Manager Driver Administration Guide*.

C ndsrep

The ndsrep program is used to publish information from the Notes database to the Identity Vault (Publisher channel). It is not required if you are only sending information from the Identity Vault to the Notes database (Subscriber channel).

The following sections provide information about using ndsrep.

- ♦ [“Prerequisite for setting up ndsrep” on page 127](#)
- ♦ [“Setting Up ndsrep” on page 127](#)
- ♦ [“Initiating ndsrep” on page 127](#)
- ♦ [“Loading ndsrep” on page 128](#)
- ♦ [“Controlling ndsrep” on page 129](#)
- ♦ [“Setting Up Multiple Instances of ndsrep” on page 129](#)

Prerequisite for setting up ndsrep

NDSREP is the component of Lotus Notes Driver. It is dependent on one of the connected system’s Library, **GSKit ICC library**. **GSKit ICC library** is provided by IBM Fix Central for respective platforms. Since **NDSREP** component is dependent on **GSKit ICC library**, by default, as a prerequisite, it is required to download the **GSKit ICC library**.

NOTE: It is recommended to download GSKit ICC library, if the Notes Domino has to be upgraded to version 11 or later.

Setting Up ndsrep

- 1 Review the information about ndsrep in [“Subscriber Channel” on page 12](#).
- 2 Make sure you have copied the necessary files for your platform, as described in [“Copying ndsrep and notes.jar to the Required Locations” on page 18](#).
- 3 (Windows only) Add C:\lotus\domino (or the appropriate Domino executable folder) to your system path, then reboot the computer.
- 4 Before trying to load ndsrep, ensure that the Identity Manager driver for Lotus Notes has been started at least once.

Initiating ndsrep

To initiate ndsrep, which is a one-time process:

- 1 Ensure that the .ntf files have the right settings (permissions).
- 2 Start the Identity Manager driver for Lotus Notes and let it poll once (heartbeat).

This creates the `dsrepcfg.nsf` file.

- 3 Execute the following command to load `ndsrep`:

```
load ndsrep instance
```

The instance is available in `dsrepcfg.nsf`, after you have started the driver. Typically, the instance name is the driver name in capital letters.

Loading `ndsrep`

You always load and run `ndsrep` at the server console on the Domino server. The `ndsrep` program creates an output database (by default, `ndsrep.nsf`), detects changes in the Public address book in the Domino server (or other Notes database), and copies these changes to the output database.

You can load `ndsrep` through two automated methods or through one manual method.

- ♦ [“Automated Method 1” on page 128](#)
- ♦ [“Automated Method 2” on page 128](#)
- ♦ [“Manual Method” on page 128](#)

Automated Method 1

- 1 Load `ndsrep` in the Domino server console.
- 2 Add `ndsrep` to the `ServerTasks =` statement in `notes.ini` and restart the Domino server,
For example:

```
ServerTasks=Update,Replica,Router,AMgr,AdminP,ndsrep notesdrv1,  
CalConn,Sched,HTTP,IMAP,POP3
```

Automated Method 2

- 1 Create a Program document to run `ndsrep`.
Refer to your Domino Administrator documentation for information about how to create a Program document.
The Program document causes `ndsrep` to start each time the Domino server starts.
- 2 When creating the Program document, use the following information:
 - ♦ Program name: `ndsrep`.
 - ♦ Command: `NotesDrv1`

Manual Method

- 1 Enter the following in the Notes Server Console window:

```
load ndsrep instance
```

If the name of your driver includes spaces, you must put quotes around the name.

Controlling ndsrep

ndsrep uses the `TELL` commands described below. The commands allow for immediate ndsrep actions. These commands are not stored; ndsrep simply executes the action.

RefreshConfig: Reads ndsrep configuration information from the configuration store.

Replicate: Forces an immediate check for updated notes.

Resume: Sets ndsrep to resume processing timer events and replication.

ShowConfig: Displays ndsrep configuration settings in the console window.

ShowFilter: Displays the first 240 characters of the filter for updated records that ndsrep is using when publishing.

Suspend: Suspends activity until the `Resume` command is given.

Setting Up Multiple Instances of ndsrep

You can run multiple instances of ndsrep to support multiple drivers running against a single Domino server. You must specify the appropriate driver instance name as a parameter when loading ndsrep. By default, this instance name is the name of the driver.

If the name of your driver includes spaces, you must put quotes around the name.

Suppose you want to synchronize `names.nsf` and `addressbook.nsf` databases. To synchronize the databases, use the following procedure:

- 1 Configure two Notes drivers, one for each database.
- 2 Run two instances of ndsrep, one for each synchronized database.
- 3 Configure ndsrep to write cache files with different names such as `ndsrep.nsf` and `ndsrep2.nsf`.
- 4 Configure the second driver to read the second cache file (`ndsrep2.nsf`).
- 5 To change the default Notes database that is synchronized by the driver, change the value of the [Directory File](#) from `names.nsf` to `addressbook.nsf`.

Consider the following important issues with setting up multiple instances of ndsrep:

- ♦ To load ndsrep, you must use the appropriate instance name:

```
load ndsrep instance
```

ndsrep is loaded and referenced by using `TELL` commands by the value of *instance*.

- ♦ When modifying `notes.ini` to auto load multiple instances of ndsrep, simply insert `ndsrep instance` multiple times on the `ServerTask` line of `notes.ini`.

For example:

```
ServerTasks=Update,Replica,Router,AMgr,AdminP,  
ndsrep notesdrv1,ndsrep notesdrv2,CalConn,Sched,HTTP,IMAP,POP3
```

You can also create multiple program documents (see [“Automated Method 2” on page 128](#)).

- ◆ For custom configurations, you can make ndsrep to utilize a different configuration database. To do so, use the ndsrep configuration parameter and load ndsrep by using the `-f filename` parameter as noted in [ndsrep configuration database](#) and [ndsrep configuration instance](#) in the parameters table in [Chapter 5, “Customizing the Driver,” on page 37](#).

D Sample XDS Documents for Custom Parameters

The driver supports using AdminP processes such as Delete, Move, and Rename. Turn on AdminP support for the driver (see [Allow Domino AdminP Support](#) in “Subscriber Options” on page 44), and make changes to your driver policy.

The driver also supports sending commands to the Domino server console.

This section provides samples of the event produced by the Identity Manager engine, and the command that must be given to the driver shim. Policy samples are not provided, but the event samples show how the event must be transformed and show attributes that need to be provided by policies.

Refer to [“Move/Rename”](#) on page 93 and [“TELL AdminP Commands”](#) on page 96 for more information.

- ♦ [“Sample for Adding a User”](#) on page 131
- ♦ [“Sample for Renaming: Modifying a User Last Name”](#) on page 133
- ♦ [“Sample for Moving a User”](#) on page 135
- ♦ [“Sample for Deleting a User”](#) on page 136
- ♦ [“Samples for Sending a Command to the Domino Server Console”](#) on page 138
- ♦ [“Replication \(Rep\) Attribute Tags”](#) on page 139
- ♦ [“Sample ACL Entry Tags”](#) on page 142
- ♦ [“Setting and Modifying Lotus Notes Field Flags”](#) on page 146

Sample for Adding a User

This section shows a sample of the events when creating user John Doe in the Identity Vault.

- ♦ [“Add Event Produced by the Identity Manager Engine”](#) on page 132
- ♦ [“Add Event Received by the Notes Driver Shim”](#) on page 132

Add Event Produced by the Identity Manager Engine

```
<nds dtdversion="2.0" ndsversion="8.x">
  <source>
    <product version="2.0.5.38 ">DirXML</product>
    <contact>Novell, Inc.</contact>
  </source>
  <input>
    <add class-name="User"
      event-id="MYSERVER-NDS#20040603175534#1#1"
      qualified-src-dn="O=DirXML\OU=Notes\OU=Users\OU=sales\CN=John
Doe"
      src-dn="\mytree\DirXML\Notes\Users\sales\John Doe"
      src-entry-id="38727">
      <association state="pending"></association>
      <add-attr attr-name="CN">
        <value naming="true" timestamp="1086285300#20" type="string">John
Doe</value>
      </add-attr>
      <add-attr attr-name="Surname">
        <value timestamp="1086285300#3" type="string">Doe</value>
      </add-attr>
      <add-attr attr-name="Given Name">
        <value timestamp="1086285334#1" type="string">John</value>
      </add-attr>
    </add>
  </input>
</nds>
```

Add Event Received by the Notes Driver Shim

```
<nds dtdversion="2.0" ndsversion="8.x">
  <source>
    <product version="2.0.5.38">Identity Manager</product>
    <contact>Novell, Inc.</contact>
  </source>
  <input>
    <add
      expire-term="5" certify-user="Yes"
      class-name="Person"
      create-mail="Yes"
      dest-dn="cn=John Doe/ou=sales/o=dirxml"
      drv-param-cert-id="sales-cert-id-file" drv-param-
cert-pwd="sales-cert-id-password" enforce-unique-short-name="No"
      event-id="MYSERVER-NDS#20040603175534#1#1" internet-password-
force-change="Yes" mail-acl-level="MANAGER"
mail-acl-manager-name="CN=Notes Driver/O=dirxml" mail-file-quota="120000"
mail-quota-warning-threshold="100000" notes-password-change-
interval="100" notes-password-check-
setting="PWD_CHK_CHECKPASSWORD" notes-password-grace-period="5" notes-
policy-name="/EmployeePolicy"
      qualified-src-dn="O=DirXML\OU=Notes\OU=Users\OU=sales\CN=John
Doe"
      roaming-cleanup-period="90" roaming-cleanup-
setting="REG_ROAMING_CLEANUP_EVERY_NDAYS" roaming-server="cn=myserver/
```

```

o=dirxml"          roaming-subdir="Roaming\JohnDoe" roaming-user="Yes"
src-dn="\mytree\DirXML\Notes\Users\sales\John Doe"
src-entry-id="38727"
sync-internet-password="Yes">
  <add-attr attr-name="FullName">
    <value naming="true" timestamp="1086285300#20" type="string">John
Doe</value>
  </add-attr>
  <add-attr attr-name="LastName">
    <value timestamp="1086285300#3" type="string">Doe</value>
  </add-attr>
  <add-attr attr-name="FirstName">
    <value timestamp="1086285334#1" type="string">John</value>
  </add-attr>
  <add-attr attr-name="InternetAddress">
    <value>John Doe@dirxml.com</value>
  </add-attr>
</add>
</input>
</nds>

```

Sample for Renaming: Modifying a User Last Name

This section shows a sample of the events when changing a last name from Doe to Doerr in the Identity Vault. Refer to [“Move/Rename” on page 93](#) for more information.

- ♦ [“Modify Event Produced by the Identity Manager Engine” on page 134](#)
- ♦ [“Modify Event Received by the Notes Driver Shim” on page 134](#)

Modify Event Produced by the Identity Manager Engine

```
<nds dtdversion="2.0" ndsversion="8.x">
  <source>
    <product version="2.0.5.38 ">Identity Manager</product>
    <contact>Novell, Inc.</contact>
  </source>
  <input>
    <modify class-name="User"
      event-id="MYSERVER-NDS#20040603175500#1#3"
      qualified-src-dn="O=DirXML\OU=Notes\OU=Users\OU=sales\CN=John
Doe"
      src-dn="\mytree\DirXML\Notes\Users\sales\John Doe"
      src-entry-id="38727"
      timestamp="1086291578#2">
      <association state="associated">BB888BB0C35D13EC87256EA8006296CE</
association>
      <modify-attr attr-name="Surname">
        <remove-value>
          <value timestamp="1086285300#3" type="string">Doe</value>
        </remove-value>
        <add-value>
          <value timestamp="1086291578#2" type="string">Doerr</value>
        </add-value>
      </modify-attr>
    </modify>
  </input>
</nds>
```

Modify Event Received by the Notes Driver Shim

```
<nds dtdversion="2.0" ndsversion="8.x">
  <source>
    <product version="2.0.5.38 ">Identity Manager</product>
    <contact>Novell, Inc.</contact>
  </source>
  <input>
    <modify class-name="Person"
      drv-param-cert-id="sales-cert-id-file"   drv-param-cert-
pwd="sales-cert-id-password"
      event-id="MYSERVER-NDS#20040603175500#1#3"
      qualified-src-
dn="O=DirXML\OU=Notes\OU=Users\OU=sales\CN=John Doe"
      src-dn="\mytree\DirXML\Notes\Users\sales\John Doe"
      src-entry-id="38727"
      tell-adminp-process="tell adminp process all"
    </modify>
  </input>
</nds>
```

```

        timestamp="1086291578#2">
    <association state="associated">BB888BB0C35D13EC87256EA8006296CE</
association>
    <modify-attr attr-name="LastName">
        <remove-value>
            <value timestamp="1086285300#3" type="string">Doe</value>
        </remove-value>
        <add-value>
            <value timestamp="1086291578#2" type="string">Doerr</value>
        </add-value>
    </modify-attr>
</modify>
</input>
</nds>

```

Sample for Moving a User

This section shows a sample of the events when moving John Doerr from the OU=sales to OU=mktg in Identity Vault. Refer to [“Move/Rename” on page 93](#) for more information.

- ♦ [“Move Event Produced by the Identity Manager Engine” on page 135](#)
- ♦ [“Move Event Received by the Notes Driver Shim” on page 136](#)

Move Event Produced by the Identity Manager Engine

```

<nds dtdversion="2.0" ndsversion="8.x">
    <source>
        <product version="2.0.5.38">Identity Manager</product>
        <contact>Novell, Inc.</contact>
    </source>
    <input>
        <move class-name="User"
            event-id="MYSERVER-NDS#20040603175500#1#1"
            old-src-dn="\mytree\DirXML\Notes\Users\sales\John Doerr"

            qualified-old-src-
dn="O=DirXML\OU=Notes\OU=Users\OU=sales\CN=John Doerr"

            qualified-src-dn="O=DirXML\OU=Notes\OU=Users\OU=mktg\CN=John
Doerr"

            src-dn="\mytree\DirXML\Notes\Users\mktg\John Doerr"
            src-entry-id="38727"
            timestamp="1086285300#1">
        <association state="associated">BB888BB0C35D13EC87256EA8006296CE</
association>
        <parent qualified-src-dn="O=DirXML\OU=Notes\OU=Users\OU=mktg"
            src-dn="\mytree\DirXML\Notes\Users\mktg" src-entry-
id="36691"/>
    </move>
</input>
</nds>

```

Move Event Received by the Notes Driver Shim

```
<nds dtdversion="2.0" ndsversion="8.x">
  <source>
    <product version="2.0.5.38 ">Identity Manager</product>
    <contact>Novell, Inc.</contact>
  </source>
  <input>
    <move   certifier-name="/mktg/dirxml"
            class-name="Person"
            drv-param-cert-id="mktg-cert-id-file"                drv-param-
certpwd="mktg-cert-id-password"                drv-param-old-cert-id="sales-cert-
idfile"                drv-param-old-cert-pwd="sales-cert-id-password"
            event-id="MYSERVER-NDS#20040603175500#1#1"
            old-src-dn="\mytree\DirXML\Notes\Users\sales\John Doerr"
            qualified-old-src-
dn="O=DirXML\OU=Notes\OU=Users\OU=sales\CN=John Doerr"
            qualified-src-dn="O=DirXML\OU=Notes\OU=Users\OU=mktg\CN=John
Doerr"
            src-entry-id="38727"
            src-dn="\mytree\DirXML\Notes\Users\mktg\John Doerr"
tell-adminp-process="tell adminp process all"
            timestamp="1086285300#1">
      <association state="associated">BB888BB0C35D13EC87256EA8006296CE</
association>
      <parent qualified-src-dn="O=DirXML\OU=Notes\OU=Users\OU=mktg"
            src-dn="\mytree\DirXML\Notes\Users\mktg" src-entry-
id="36691"/>
    </move>
  </input>
</nds>
```

Sample for Deleting a User

This section shows a sample of the events when deleting John Doerr from Identity Vault.

- ♦ [“Delete Event Produced by the Identity Manager Engine” on page 137](#)
- ♦ [“Delete Event Received by the Notes Driver Shim” on page 137](#)

Delete Event Produced by the Identity Manager Engine

```
<nds dtdversion="2.0" ndsversion="8.x">
  <source>
    <product version="2.0.5.38 ">Identity Manager</product>
    <contact>Novell, Inc.</contact>
  </source>
  <input>
    <delete class-name="User"
      event-id="MYSERVER-NDS#20040603195215#1#6"
      qualified-src-dn="O=DirXML\OU=Notes\OU=Users\OU=mktg\CN=John
Doerr"
      src-dn="\mytree\DirXML\Notes\Users\mktg\John Doerr"
      src-entry-id="38727"
      timestamp="1086292335#6">
      <association state="associated">BB888BB0C35D13EC87256EA8006296CE</
association>
    </delete>
  </input>
</nds>
```

Delete Event Received by the Notes Driver Shim

```
<nds dtdversion="2.0" ndsversion="8.x">
  <source>
    <product version="2.0.5.38 ">Identity Manager</product>
    <contact>Novell, Inc.</contact>
  </source>
  <input>
    <delete class-name="Person"
      delete-windows-user="false" deny-access-group-
id="7EFB951A3574521F87256E540001F140"
      event-id="MYSERVER-NDS#20040603195215#1#6"
      immediate="true" mail-file-action="MAILFILE_DELETE_ALL"
      qualified-src-dn="O=DirXML\OU=Notes\OU=Users\OU=mktg\CN=John Doerr"
      src-dn="\mytree\DirXML\Notes\Users\mktg\John Doerr"
      src-entry-id="38727"
      tell-adminp-process="tell adminp process all"
      timestamp="1086292335#6">
      <association state="associated">BB888BB0C35D13EC87256EA8006296CE</
association>
    </delete>
  </input>
</nds>
```

Samples for Sending a Command to the Domino Server Console

This section shows a sample of using the driver's ability to send a command to the Domino server console and receive a response.

- ♦ [“Domino Console Command Received by the Driver Shim” on page 138](#)
- ♦ [“Command Response Returned by the Notes Driver Shim” on page 138](#)

Domino Console Command Received by the Driver Shim

```
<nds dtdversion="1.0" ndsversion="8.5" xmlns:notes="http://www.netiq.com/
dirxml/notesdriver">
  <input>
    <notes:domino-console-command event-id="0">show server -xml</
notes:domino-console-command>
  </input>
</nds>
```

Command Response Returned by the Notes Driver Shim

Responses are truncated after 32000 characters.

```
<nds dtdversion="2.0" ndsversion="8.x" xmlns:notes="http://www.netiq.com/
dirxml/notesdriver">
  <source>
    <product build="20040602_1644" instance="NotesDriver"
version="2.1">Identity Manager Driver for Lotus Notes</product>
    <contact>Novell, Inc.</contact>
  </source>
  <output>
    <notes:domino-console-response event-id="0">
      <server platform="Windows/32" time="20040603T141140,48-06"
version="Release 6.5">
        <name>myserver/dirxml</name>
        <title>MyServer Domino Server</title>
        <directory>C:\Lotus\Domino\Data</directory>
        <partition>C.Lotus.Domino.Data</partition>
        <uptime days="6" hours="1" minutes="52" seconds="38"/>
        <transactions hour="80" minute="2" peak="3614"/>
        <sessions peaknumber="5" peaktime="20040528T130914,23-06"/>
        <transactions count="35797" maxconcurrent="20"/>
        <threadpool threads="40"/>
        <availability index="100" state="AVAILABLE"/>
        <mailtracking enabled="0" state="Not Enabled"/>
        <mailjournaling enabled="0" state="Not Enabled"/>
        <sharedmail enabled="0" state="Not Enabled"/>
        <mailboxes number="1"/>
        <mail dead="0" pending="0"/>
        <tasks waiting="0"/>
        <transactionlogging enabled="0"/>
        <hosting enabled="0"/>
      </server>
    </notes:domino-console-response>
  </output>
</nds>
```

```

        <faultrecovery enabled="0" state="Not Enabled"/>
        <activitylogging enabled="0" state="Not Enabled"/>
        <controller enabled="0" state="Not Enabled"/>

<diagnosticdirectory>C:\Lotus\Domino\Data\IBM_TECHNICAL_SUPPORT</
diagnosticdirectory>
        <consolelogging enabled="0" state="Not Enabled"/>

<consolelogfile>C:\Lotus\Domino\Data\IBM_TECHNICAL_SUPPORT\console.log</
consolelogfile>
        </server>
        </notes:domino-console-response>
        <status event-id="0" level="success"/>
</output>
</nds>

```

Replication (Rep) Attribute Tags

- ♦ “The ADD Event Policy Rule for Database Replication” on page 139
- ♦ “Mailfile Database Replication Attribute Tags That Are Submitted to the Shim” on page 139
- ♦ “Sample Modify Event Policy Rule” on page 141
- ♦ “Modify Event Attribute Tags That Are Submitted to the Shim” on page 141

The ADD Event Policy Rule for Database Replication

To view a sample ADD Event policy rule to submit database replication parameters on behalf of a newly created mailfile, click [setmailfilerrep.xml](#) ([../samples/setmailfilerrep.xml](#)). You can use or modify the sample code for your own XML solutions.

Mailfile Database Replication Attribute Tags That Are Submitted to the Shim

The following sample shows an add event containing mailfile database replication attribute tags as they are submitted to the Notes Driver shim. This sample modifies the replication settings of the newly created mailfile of the new Notes user and also creates a replica on server CN=server1/O=novell.

```

<nds dtdversion="2.0" ndsversion="8.x">
  <source>
    <product version="2.0.8.20050127 ">Identity Manager</product>
    <contact>Novell, Inc.</contact>
  </source>
  <input>
    <add certify-user="true"
      class-name="Person"
      create-mail="true"
      dest-dn="CN=DaffyDuck/OU=eng/O=novell"
      drv-param-cert-id="eng-cert-id-file"
      drv-param-cert-pwd="eng-cert-id-password"
      event-id="BLACKCAP-NDS#20050331215122#1#1"
      mail-acl-manager-name="CN=Notes Driver/O=novell"
      mailfile-rep-abstract="false"
      mailfile-rep-clear-history="false"
      mailfile-rep-cutoff-delete="false"
      mailfile-rep-cutoff-interval="240"
      mailfile-rep-dest-server="CN=server1/O=novell"
      mailfile-rep-disabled="false"
      mailfile-rep-dont-send-local-security-updates="false"
      mailfile-rep-entry-remove="false"
      mailfile-rep-ignore-deletes="false"
      mailfile-rep-ignore-dest-deletes="false"
      mailfile-rep-immediate="CN=server1/O=novell"
      mailfile-rep-include-acl="true"
      mailfile-rep-include-agents="true"
      mailfile-rep-include-documents="true"
      mailfile-rep-include-forms="true"
      mailfile-rep-include-formulas="true"
      mailfile-rep-new-db-name="mail/daffyduck_repl.nsf"
      mailfile-rep-new-server="CN=server1/O=novell"
      mailfile-rep-priority="LOW"
      mailfile-rep-src-server="CN=server2/O=novell"
      mailfile-rep-view-list="Inbox;Sent;Calendar;Meetings"
      qualified-src-dn="O=DirXML\OU=Notes\OU=Users\OU=eng\CN=DaffyDuck"
      src-dn="\novell_tree\DirXML\Notes\Users\eng\DaffyDuck"
      src-entry-id="40729"
      timestamp="1112305882#22">
      <add-attr attr-name="FullName">
        <value timestamp="1112305882#22" type="string">DaffyDuck</value>
      </add-attr>
      <add-attr attr-name="LastName">
        <value timestamp="1112305882#7" type="string">Duck</value>
      </add-attr>
      <add-attr attr-name="FirstName">
        <value timestamp="1112305882#5" type="string">Daffy</value>
      </add-attr>
      <add-attr attr-name="InternetAddress">
        <value>DaffyDuck@novell.com</value>
      </add-attr>
    </add>
  </input>
</nds>

```

Sample Modify Event Policy Rule

To view sample code for a Modify Event policy rule to submit database replication parameters, see [setsyncdbrep.xml \(./samples/setsyncdbrep.xml\)](#). You can use or modify the code sample in your own XML solutions.

Modify Event Attribute Tags That Are Submitted to the Shim

A sample Modify Event containing database replication attribute tags as submitted to the Notes Driver shim. This sample modifies the synchronized `.nsf` database (in this case `names.nsf`):

```
<nds dtdversion="2.0" ndsversion="8.x">
  <source>
    <product version="2.0.8.20050127 ">Identity Manager</product>
    <contact>Novell, Inc.</contact>
  </source>
  <input>
    <modify class-name="Group"
      event-id="BLACKCAP-NDS#20050401191642#1#1"
      qualified-src-dn="O=DirXML\OU=Notes\OU=Groups\CN=Engineering"
      rep-abstract="false"
      rep-clear-history="false"
      rep-cutoff-delete="false"
      rep-cutoff-interval="240"
      rep-dest-server="CN=server1/O=novell"
      rep-disabled="false"
      rep-dont-send-local-security-updates="true"
      rep-entry-remove="false"
      rep-ignore-deletes="false"
      rep-ignore-dest-deletes="false"
      rep-immediate="CN=server1/O=novell"
      rep-include-acl="true"
      rep-include-agents="true"
      rep-include-documents="true"
      rep-include-forms="true"
      rep-include-formulas="true"
      rep-priority="HIGH"
      rep-src-server="CN=server2/O=novell"
      rep-view-list="People;People By Category;Groups;Groups By Category"
      src-dn="\novell_tree\DirXML\Notes\Groups\Engineering"
      src-entry-id="40743"
      timestamp="1112383002#1">
      <association state="associated">3EEB6FC36CBE4D3687256FD60069C721</
association>
      <modify-attr attr-name="ListDescription">
        <add-value>
          <value timestamp="1112383002#1" type="string">Software Engineering
Group</value>
        </add-value>
      </modify-attr>
    </modify>
  </input>
</nds>
```

Sample ACL Entry Tags

The `acl-entry-enable-role` and `acl-entry-disable-role` tag values require a list of the roles that are defined in the ACL record. They also accept the `[[ALL]]` tag, which indicates using all of the roles defined in the ACL record.

You can select all roles with the string `acl-entry-enable-role="[[ALL]]"`. This is equivalent to `acl-entry-enable-role="[GroupCreator] [GroupModifier] [NetCreator] [NetModifier] [PolicyCreator] [PolicyModifier] [PolicyReader] [ServerCreator] [ServerModifier] [UserCreator] [UserModifier]"` for `names.nsf`.

You can deselect all roles with the string `acl-entry-disable-role="[[ALL]]"`. This is equivalent to `acl-entry-disable-role="[GroupCreator] [GroupModifier] [NetCreator] [NetModifier] [PolicyCreator] [PolicyModifier] [PolicyReader] [ServerCreator] [ServerModifier] [UserCreator] [UserModifier]"` for `names.nsf`.

- ♦ [“ADD Event Policy Rule To Submit ACLEntry Parameters” on page 142](#)
- ♦ [“Add Event ACLEntry Tags That Are Submitted To the Notes Driver Shim” on page 142](#)
- ♦ [“Sample Modify Event Policy Rule” on page 143](#)
- ♦ [“Modify Event As Submitted To the Notes Driver Shim” on page 145](#)

ADD Event Policy Rule To Submit ACLEntry Parameters

To view sample code for the ADD Event policy rule to submit ACLEntry parameters, see [setsyncdbacladd.xml \(../samples/setsyncdbacladd.xml\)](#). You can use or modify the code sample for your own XML solutions.

Add Event ACLEntry Tags That Are Submitted To the Notes Driver Shim

The following sample shows the Add Event containing ACLEntry tags as they are submitted to the Notes Driver shim:

```
<nds dtdversion="2.0" ndsversion="8.x">
  <source>
    <product version="2.0.5.51 ">Identity Manager</product>
    <contact>Novell, Inc.</contact>
  </source>
  <input>
    <add acl-entry-can-create-documents="true"
      acl-entry-can-create-ls-or-java-agent="true"
      acl-entry-can-create-personal-agent="true"
      acl-entry-can-create-personal-folder="true"
      acl-entry-can-create-shared-folder="true"
      acl-entry-can-delete-documents="true"
      acl-entry-can-replicate-or-copy-documents="true"
      acl-entry-enable-role="[[ALL]]"
      acl-entry-level="MANAGER"
      acl-entry-public-reader="true"
      acl-entry-public-writer="true"
      acl-entry-user-type="PERSON">
```

```

certify-user="true"
class-name="Person"
create-mail="true"
dest-dn="CN=DaffyDuck/OU=sales/O=novell"
drv-param-cert-id="sales-cert-id-file"
drv-param-cert-pwd="sales-cert-id-password"
event-id="MYSERVER-NDS#20040920214955#1#1"
expire-term="2"
mail-acl-manager-name="CN=Notes Driver/O=novell"
qualified-src-dn="O=DirXML\OU=Notes\OU=Users\OU=sales\CN=DaffyDuck"
src-dn="\mytree\DirXML\Notes\Users\sales\DaffyDuck"
src-entry-id="39862">
<add-attr attr-name="FullName">
<value naming="true" timestamp="1095716982#20"
      type="string">DaffyDuck</value>
</add-attr>
<add-attr attr-name="LastName">
<value timestamp="1095716982#3" type="string">Duck</value>
</add-attr>
<add-attr attr-name="FirstName">
<value timestamp="1095716995#1" type="string">Daffy</value>
</add-attr>
      <add-attr attr-name="InternetAddress">
<value>DaffyDuck@novell.com</value>
</add-attr>
</add>
</input>
</nds>

```

Sample Modify Event Policy Rule

The following sample shows a Modify Event policy rule to submit ACLEntry parameters to the Notes Driver shim:

```

<rule>
  <description>Apply ACL entry attributes to MODIFY events</description>
  <conditions>
    <or disabled="true">
      <if-operation op="equal">modify</if-operation>
    </or>
  </conditions>
  <actions>
    <do-set-xml-attr expression="../modify" name="acl-entry-public-reader">
      <arg-string>
        <token-text>true</token-text>
      </arg-string>
    </do-set-xml-attr>
    <do-set-xml-attr expression="../modify" name="acl-entry-public-writer">
      <arg-string>
        <token-text>true</token-text>
      </arg-string>
    </do-set-xml-attr>
    <do-set-xml-attr expression="../modify" name="acl-entry-level">
      <arg-string>

```

```

    <token-text>MANAGER</token-text>
  </arg-string>
</do-set-xml-attr>
<do-set-xml-attr expression="../modify" name="acl-entry-user-type">
  <arg-string>
    <token-text>PERSON</token-text>
  </arg-string>
</do-set-xml-attr>
<do-set-xml-attr expression="../modify" name="acl-entry-enable-role">
  <arg-string>
    <token-text>[[ALL]]</token-text>
  </arg-string>
</do-set-xml-attr>
<do-set-xml-attr expression="../modify" name="acl-entry-disable-role">
  <arg-string>
    <token-text xml:space="preserve">[NetCreator] [NetModifier]</token-
text>
  </arg-string>
</do-set-xml-attr>
<do-set-xml-attr expression="../modify" name="acl-entry-can-create-
documents">
  <arg-string>
    <token-text>true</token-text>
  </arg-string>
</do-set-xml-attr>
<do-set-xml-attr expression="../modify" name="acl-entry-can-create-ls-
or-java-agent">
  <arg-string>
    <token-text>true</token-text>
  </arg-string>
</do-set-xml-attr>
<do-set-xml-attr expression="../modify" name="acl-entry-can-create-
personal-agent">
  <arg-string>
    <token-text>true</token-text>
  </arg-string>
</do-set-xml-attr>
<do-set-xml-attr expression="../modify" name="acl-entry-can-create-
personal-folder">
  <arg-string>
    <token-text>true</token-text>
  </arg-string>
</do-set-xml-attr>
<do-set-xml-attr expression="../modify" name="acl-entry-can-create-
shared-folder">
  <arg-string>
    <token-text>true</token-text>
  </arg-string>
</do-set-xml-attr>

```



```

    <do-set-xml-attr expression="../modify" name="acl-entry-can-delete-
documents">
      <arg-string>
        <token-text>true</token-text>
      </arg-string>
    </do-set-xml-attr>
    <do-set-xml-attr expression="../modify" name="acl-entry-can-replicate-
or-copy-documents">
      <arg-string>
        <token-text>true</token-text>
      </arg-string>
    </do-set-xml-attr>
  </actions>
</rule>

```

Modify Event As Submitted To the Notes Driver Shim

The following sample shows the Modify Event containing ACLEntry tags as they are submitted to the Notes Driver shim:

```

<nds dtdversion="2.0" ndsversion="8.x">
  <source>
    <product version="2.0.5.51 ">Identity Manager</product>
    <contact>Novell, Inc.</contact>
  </source>
  <input>
    <modify acl-entry-can-create-documents="true"
      acl-entry-can-create-ls-or-java-agent="true"
      acl-entry-can-create-personal-agent="true"
      acl-entry-can-create-personal-folder="true"
      acl-entry-can-create-shared-folder="true"
      acl-entry-can-delete-documents="true"
      acl-entry-can-replicate-or-copy-documents="true"
      acl-entry-disable-role="[NetCreator] [NetModifier]"
      acl-entry-enable-role="[[ALL]]"
      acl-entry-level="MANAGER"
      acl-entry-public-reader="true"
      acl-entry-public-writer="true"
      acl-entry-user-type="PERSON" class-name="Person"
      event-id="MYSERVER-NDS#20040920215410#1#1"
      qualified-src-dn="O=DirXML\OU=Notes\OU=Users\OU=sales\CN=DaffyDuck"
      src-dn="\mytree\DirXML\Notes\Users\sales\DaffyDuck"
    >
  </input>
</nds>

```

```

        src-entry-id="39862" timestamp="1095717426#2">
        <association state="associated">BE64D2CAAB6EADD987256F150077EF7B</
association>
        <modify-attr attr-name="OfficePhoneNumber">
        <remove-value>
        <value timestamp="1095717250#1" type="teleNumber">444-4444</value>
        </remove-value>
        <add-value>
        <value timestamp="1095717426#2" type="teleNumber">555-1212</value>
        </add-value>
        </modify-attr>
    </modify>
</input>
</nds>

```

Setting and Modifying Lotus Notes Field Flags

The Notes Driver v2.1.1 and above can set (add) or modify Lotus Notes field flags on documents (records) in a Lotus Notes database (.nsf) that is being synchronized (Subscriber channel only). Available Lotus Notes field flags that the driver can appropriately set are **read-access**, **read/write-access**, **names**, **protected**, and **summary**. The **seal** and **sign** flags can also be enabled or disabled, but without the expected supporting functionality.

Each Notes field flag can be set enabled or disabled by using a corresponding XML tag.

driver-attr-flag	Notes Field Flag
authors-flag	READ/WRITE-ACCESS
encrypted-flag	SEAL
names-flag	NAMES
protected-flag	PROTECTED
readers-flag	READ-ACCESS
signed-flag	SIGN
summary-flag	SUMMARY

You can insert these XML tags (driver-attr-flags) into XDS documents of the Subscriber channel as attributes of the <add-attr> or <modify-attr> elements (siblings to the attr-name attribute). The field flags must be used in the appropriate manner, according to Lotus Notes database schema and design rules. Inappropriate flags (or flag combinations) on a field can cause unexpected results for that document (record).

For example, it is possible for uncertified users to be removed from the view of the Notes Address book (rendering them inaccessible) when certain attribute flags (readers-flag, authors-flag) are set inappropriately on a field that cannot handle the flag.

The encrypted-flag can be set for a field, even though the driver does not take the necessary steps to call the encryption methods with appropriate certificates. It is possible to set a field as **SEAL**, but some other code needs to call the appropriate methods to encrypt the field in the document, or the field is not actually sealed (encrypted).

- ♦ [“Sample Creation Policy Rules” on page 147](#)
- ♦ [“Sample Modify Policy Rule” on page 147](#)
- ♦ [“Sample Add XDS Doc” on page 147](#)
- ♦ [“Sample Modify XDS Doc” on page 148](#)

Sample Creation Policy Rules

To view a sample of using the field flags in creation policy rules, see [setfieldflagsadd.xml \(../samples/setfieldflagsadd.xml\)](#). You can use or modify the code sample for your own XML solutions.

Sample Modify Policy Rule

To view a sample of a Modify policy rule in the command transform, see [setfieldflagsmodify.xml \(../samples/setfieldflagsmodify.xml\)](#). You can use or modify the code sample for your own XML solutions.

Sample Add XDS Doc

The following sample shows an Add XDS doc before it is submitted to the Notes Driver shim:

```
<nds dtdversion="2.0" ndsversion="8.x">
  <source>
    <product version="2.0.5.51 ">Identity Manager</product>
    <contact>Novell, Inc.</contact>
  </source>
  <input>
    <add certify-user="true"
      class-name="Person"
      create-mail="true"
      dest-dn="CN=ErnieEngineer/OU=eng/O=novell"
      drv-param-cert-id="eng-cert-id-file"
      drv-param-cert-pwd="eng-cert-id-password"
      event-id="BLACKCAP-NDS#20040915163542#1#1"
      expire-term="22"
      internet-password-force-change="false"
      mail-acl-manager-name="CN=Notes Driver/O=novell"
      mail-file-inherit-flag="true"
      no-id-file="false"
      notes-password-change-interval="0"
      notes-password-check-setting="PWD_CHK_CHECKPASSWORD"
      notes-password-grace-period="0"
      qualified-src-
dn="O=DirXML\OU=Notes\OU=Users\OU=eng\CN=ErnieEngineer"
      roaming-cleanup-period="90"
      roaming-cleanup-setting="REG_ROAMING_CLEANUP_EVERY_NDAYS"
      roaming-server="CN=blackcap/O=novell"
```

```

        roaming-subdir="Roaming\ErnieEngineer"
        roaming-user="false" src-
dn="\raspberry\DirXML\Notes\Users\eng\ErnieEngineer"
        src-entry-id="39853"
        store-useridfile-in-ab="true"
        sync-internet-password="true">
        <add-attr attr-name="FullName">
        <value naming="true" timestamp="1095266118#20"
type="string">ErnieEngineer</value>
        </add-attr>
        <add-attr attr-name="LastName">
        <value timestamp="1095266118#3" type="string">Engineer</value>
        </add-attr>
        <add-attr attr-name="FirstName">
        <value timestamp="1095266142#1" type="string">Ernie</value>
        </add-attr>
        <add-attr attr-name="InternetAddress">
        <value>ErnieEngineer@novell.com</value>
        </add-attr>
        <add-attr attr-name="ShoeSize" authors-flag="false" encrypted-
flag="false" names-flag="false" protected-flag="true" readers-flag="false"
signed-flag="false" summary-flag="true">
        <value type="string">9.5</value>
        </add-attr>
    </add>
</input>
</nds>

```

Sample Modify XDS Doc

The following a sample shows a Modify XDS doc before it is submitted to the Notes Driver shim:

```

<nds dtdversion="2.0" ndsversion="8.x">
    <source>
    <product version="2.0.5.51 ">Identity Manager</product>
    <contact>Novell, Inc.</contact>
    </source>
    <input>
    <modify class-name="Person"
        event-id="BLACKCAP-NDS#20040915164613#1#1"
        qualified-src-
dn="O=DirXML\OU=Notes\OU=Users\OU=eng\CN=ErnieEngineer"
        src-dn="\raspberry\DirXML\Notes\Users\eng\ErnieEngineer"
        src-entry-id="39853" tell-adminp-process="tell adminp process all"
timestamp="1095267005#2">
        <association state="associated">A4C23EE8273577AF87256F10005B2BF9</
association>
        <modify-attr attr-name="OfficePhoneNumber"
            authors-flag="false"
            encrypted-flag="false"
            names-flag="false"

```

```
        protected-flag="true"
        readers-flag="false"
        signed-flag="false"
        summary-flag="true">
    <remove-value>
        <value timestamp="1095266773#1" type="teleNumber">222-2222</value>
    </remove-value>
    <add-value>
        <value timestamp="1095267005#2" type="teleNumber">222-2221</value>
    </add-value>
    </modify-attr>
</modify>
</input>
</nds>
```

