

Credential Provisioning

Identity Manager 4.0.2

June 2012

Legal Notices

Novell, Inc. makes no representations or warranties with respect to the contents or use of this documentation, and specifically disclaims any express or implied warranties of merchantability or fitness for any particular purpose. Further, Novell, Inc. reserves the right to revise this publication and to make changes to its content, at any time, without obligation to notify any person or entity of such revisions or changes.

Further, Novell, Inc. makes no representations or warranties with respect to any software, and specifically disclaims any express or implied warranties of merchantability or fitness for any particular purpose. Further, Novell, Inc. reserves the right to make changes to any and all parts of Novell software, at any time, without any obligation to notify any person or entity of such changes.

Any products or technical information provided under this Agreement may be subject to U.S. export controls and the trade laws of other countries. You agree to comply with all export control regulations and to obtain any required licenses or classification to export, re-export or import deliverables. You agree not to export or re-export to entities on the current U.S. export exclusion lists or to any embargoed or terrorist countries as specified in the U.S. export laws. You agree to not use deliverables for prohibited nuclear, missile, or chemical biological weaponry end uses. See the [Novell International Trade Services Web page \(http://www.novell.com/info/exports/\)](http://www.novell.com/info/exports/) for more information on exporting Novell software. Novell assumes no responsibility for your failure to obtain any necessary export approvals.

Copyright © 2007-2012 Novell, Inc. All rights reserved. No part of this publication may be reproduced, photocopied, stored on a retrieval system, or transmitted without the express written consent of the publisher.

Novell, Inc.
1800 South Novell Place
Provo, UT 84606
U.S.A.
www.novell.com

Online Documentation: To access the latest online documentation for this and other Novell products, see [the Novell Documentation Web page \(http://www.novell.com/documentation\)](http://www.novell.com/documentation).

Novell Trademarks

For Novell trademarks, see [the Novell Trademark and Service Mark list \(http://www.novell.com/company/legal/trademarks/tmlist.html\)](http://www.novell.com/company/legal/trademarks/tmlist.html).

Third-Party Materials

All third-party trademarks are the property of their respective owners.

Contents

About This Guide	5
Part I Implementing Credential Provisioning with Novell SecureLogin	7
1 Overview	9
2 Requirements	13
3 Implementing Credential Provisioning	15
3.1 Extending the LDAP Schema	15
3.2 Determining Deployment Configuration Parameters for Novell SecureLogin	16
3.2.1 Example Provisioning Configuration Data	17
3.3 Creating a Repository Object	19
3.3.1 Creating a Repository Object in Designer	19
3.3.2 Creating a Repository Object in iManager	20
3.4 Creating an Application Object	22
3.4.1 Creating an Application Object in Designer	22
3.4.2 Creating an Application Object in iManager	24
3.5 Creating Credential Provisioning Policies	26
3.5.1 Creating Credential Provisioning Policies in Designer	26
3.5.2 Creating Credential Provisioning Policies in iManager	28
3.6 Example Credential Provisioning Policies	29
3.7 Operation Data Caching	30
3.8 SecureLogin Provisioning	31
3.9 SecureLogin Deprovisioning	31
4 Managing Credential Provisioning	33
4.1 Managing the Repository and Application Objects	33
4.2 Managing the Credential Provisioning Policies	34
Part II Implementing Credential Provisioning with Novell SecretStore	35
5 Overview	37
6 Requirements	41
7 Implementing Credential Provisioning	43
7.1 Determining Deployment Configuration Parameters	43
7.1.1 Example Provisioning Configuration Data	44
7.2 Creating a Repository Object	46
7.2.1 Creating a Repository Object in Designer	46
7.2.2 Creating a Repository Object in iManager	48
7.3 Creating an Application Object	50
7.3.1 Creating an Application Object in Designer	50

7.3.2	Creating an Application Object in iManager	52
7.4	Creating Credential Provisioning Policies	54
7.4.1	Creating Credential Provisioning Policies in Designer	54
7.4.2	Configuring Credential Provisioning Policies in iManager	55
7.5	Example Credential Provisioning Policies	56
7.6	Operation Data Caching	57
7.7	SecretStore Provisioning	58
7.8	SecretStore Deprovisioning	58

8 Managing Credential Provisioning 59

8.1	Managing the Repository and Application Objects	59
8.2	Managing the Credential Provisioning Policies	60

About This Guide

Novell Credential Provisioning for Identity Manager enhances the user provisioning abilities of any Identity Manager driver by providing the capability to simultaneously provision application credentials to the Novell SecretStore and Novell SecureLogin credential repositories. Additionally, you can provision the SecureLogin passphrase question and answer in environments where non-repudiation is desired.

These features enhance the user Single Sign-On experience and increase the return on investment of Single Sign-On technologies by eliminating the initial setup of SecureLogin account information, providing additional security to application credentials, and reducing the replication of effort normally associated with provisioning Single Sign-On credential stores for users. In addition, the Credential Provisioning can use Identity Manager policies to automatically de-provision application credentials to prevent access to application data.

This guide provides a detailed reference of how to implement Credential Provisioning with SecureLogin and SecretStore. The guide does not contain configuration information for Identity Manager, SecureLogin, or SecretStore.

- ♦ [Part I, “Implementing Credential Provisioning with Novell SecureLogin,”](#) on page 7
- ♦ [Part II, “Implementing Credential Provisioning with Novell SecretStore,”](#) on page 35

Audience

This guide is intended for Identity Manager administrators.

Feedback

We want to hear your comments and suggestions about this manual and the other documentation included with this product. Please use the User Comments feature at the bottom of each page of the online documentation, or go to www.novell.com/documentation/feedback.html and enter your comments there.

Documentation Updates

For the most recent version of this document, visit the [Identity Manager Web site \(http://www.netiq.com/documentation/idm402\)](http://www.netiq.com/documentation/idm402).

Additional Documentation

For documentation on Identity Manager, see the [Identity Manager Documentation Web site \(http://www.netiq.com/documentation/idm402\)](http://www.netiq.com/documentation/idm402).

For documentation on Identity Manager drivers, see the [Identity Manager Documentation Web site \(http://www.netiq.com/documentation/idm402drivers/index.html\)](http://www.netiq.com/documentation/idm402drivers/index.html).

For documentation on SecureLogin, see the [Novell SecureLogin 6.1 Documentation Web site \(http://www.netiq.com/documentation/securelogin61\)](http://www.netiq.com/documentation/securelogin61).

For documentation on SecretStore, see the [Novell SecretStore 3.4 Documentation Web site \(http://www.novell.com/documentation/secretstore34\)](http://www.novell.com/documentation/secretstore34).

Documentation Conventions

In Novell documentation, a greater-than symbol (>) is used to separate actions within a step and items in a cross-reference path.

Implementing Credential Provisioning with Novell SecureLogin

The following sections provide the concepts and instructions required to implement credential provisioning with SecureLogin:

- ♦ [Chapter 1, "Overview," on page 9](#)
- ♦ [Chapter 2, "Requirements," on page 13](#)
- ♦ [Chapter 3, "Implementing Credential Provisioning," on page 15](#)
- ♦ [Chapter 4, "Managing Credential Provisioning," on page 33](#)

1 Overview

Novell Credential Provisioning allows you to automatically provision application credentials that Novell SecureLogin supports. This section documents the steps required to configure objects and policies in Identity Manager. It does not contain deployment and configuration information for any SecureLogin components. For SecureLogin documentation, see the [Novell SecureLogin 6.1 Documentation Web Site \(http://www.novell.com/documentation/securelogin61/index.html\)](http://www.novell.com/documentation/securelogin61/index.html).

To implement Credential Provisioning with SecureLogin requires a repository object, an application object, and policies. The repository and application objects store the SecureLogin information so that Identity Manager can use it. The policies are used to enable a driver to use Credential Provisioning. See [Chapter 3, “Implementing Credential Provisioning,” on page 15](#) for more information.

You can also configure the following options:

- ◆ Credential Provisioning can be provided by the Publisher channel, Subscriber channel, or both channels.
- ◆ SecureLogin synchronization can occur as part of an application password synchronization or can be triggered by some other event.
- ◆ Web Services credentials can be provisioned without provisioning accounts for the application.
- ◆ An initial SecureLogin passphrase question and answer can be provisioned.

You can use random password generation to set the passwords for user accounts on connected systems to further secure your Identity Management environment. For more information, see “[Password Generation](#)” in the *Identity Manager 4.0.2 Security Guide* for using random password generation.

[Figure 1-1, “Credential Provisioning with SecureLogin,” on page 10](#) shows a typical, yet simple, scenario involving the provisioning of the SecureLogin credentials for a new User of a SAP Finance application in a Finance department. SAP User provisioning is used for this example because it is an application that requires more login parameters than the typical username and password provided for most applications.

This department provisions new users into the Identity Vault via a SAP HR system and Identity Manager. Depending on organizational information, the User object is then provisioned into a department authentication tree implemented on Active Directory. This is where new users authenticate to the network and is therefore the location for the SecureLogin credential repository. As users are subsequently provisioned by Identity Manager to the various finance applications, their credentials for those systems are synchronized to the SecureLogin store in Active Directory.

[Figure 1-1](#) shows user Glen’s authentication credentials being provisioned. When Glen authenticates to his department’s Active Directory authentication domain and launches the SecureLogin client, he has single sign-on to his SAP Finance account without ever needing to enter, or even know, his password on that system.

Figure 1-1 Credential Provisioning with SecureLogin

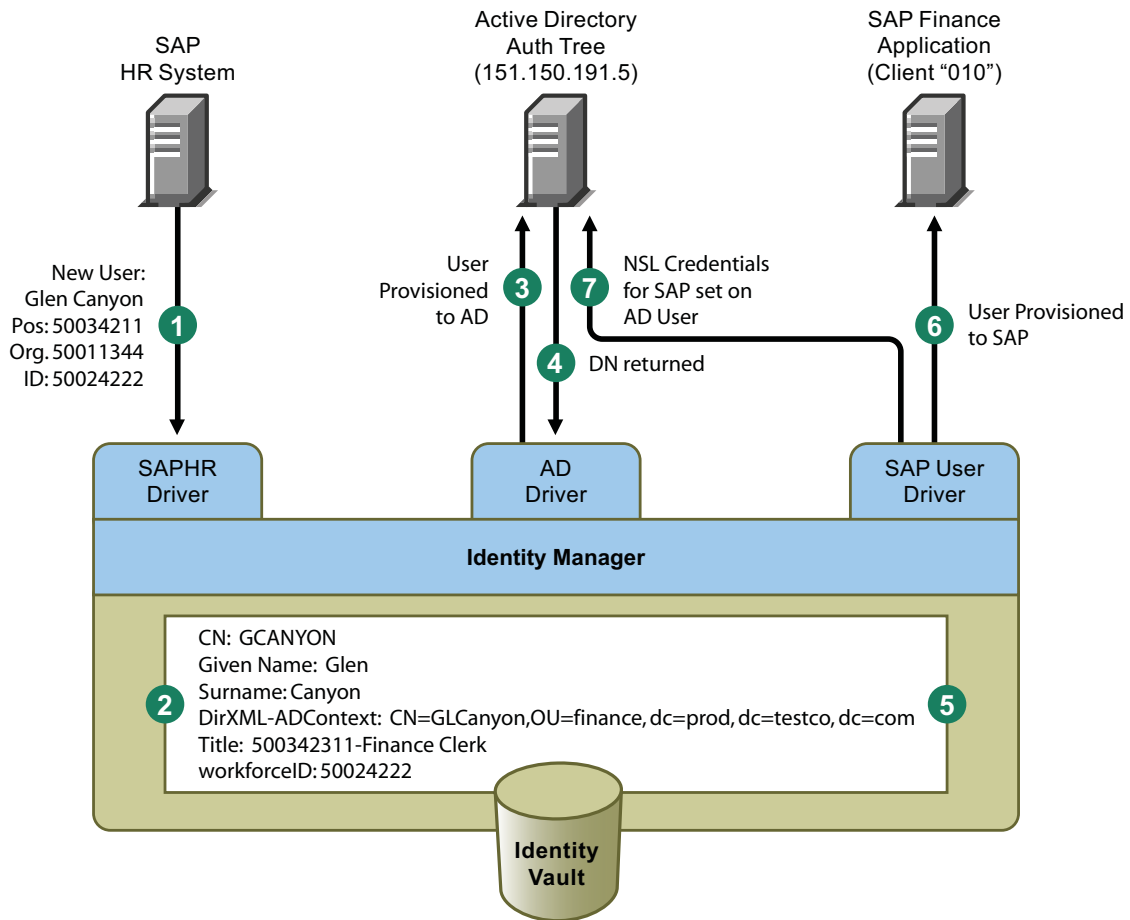

Figure 1-1 illustrates the following steps:

1. A SAP HR system publishes the data for a newly hired user named Glen Canyon. The Identity Manager SAP HR driver processes this data.
2. A new User object is created in the Identity Vault with a CN value of GCANYON and a workforceID value of 50024222. Because this user is assigned to the Finance organization of his company, he needs to authenticate to the Finance department Active Directory server in the finance.prod.testco.com domain. The Identity Manager Active Directory driver that synchronizes that domain now uses the Identity Vault information.
3. Glen is provisioned to the Finance department Active Directory server.
4. The driver is configured to obtain Glen's fully distinguished LDAP name: CN=GLCanyon,OU=finance,dc=prod,dc=testco,dc=com.
5. The driver places the name into the DirXML-ADContext attribute of the GCANYON user in the Identity Vault.

Now that the required attributes are available in the Identity Vault, the SAP User Management driver processes the attributes of the GCANYON object.

6. Because Glen is in the Finance organization, the driver provisions a SAP user account GCANYON on the SAP Finance server.
7. After the account creation is successful, the SAP User Management driver policies provision Glen's SAP authentication credentials to his AD user account. Because the command is an Add operation, the policies also provision his SecureLogin passphrase question and answer.

2 Requirements

In order to use credential provisioning with SecureLogin, the following must be in place:

- ♦ Identity Manager 3.6 or above
- ♦ `jsso.jar`, `idmcp.jar`, and `jnet.jar` must reside in the standard location for Identity Manager Java libraries.
- ♦ Novell SecureLogin 6.0 or above

3 Implementing Credential Provisioning

The implementation of Novell Credential Provisioning policies with Novell SecureLogin is very customizable. The steps to implement it are different depending upon the platform SecureLogin is installed on, the applications that are provisioned, and which Identity Manager drivers are involved.

- ♦ [Section 3.1, “Extending the LDAP Schema,” on page 15](#)
- ♦ [Section 3.2, “Determining Deployment Configuration Parameters for Novell SecureLogin,” on page 16](#)
- ♦ [Section 3.3, “Creating a Repository Object,” on page 19](#)
- ♦ [Section 3.4, “Creating an Application Object,” on page 22](#)
- ♦ [Section 3.5, “Creating Credential Provisioning Policies,” on page 26](#)
- ♦ [Section 3.6, “Example Credential Provisioning Policies,” on page 29](#)
- ♦ [Section 3.7, “Operation Data Caching,” on page 30](#)
- ♦ [Section 3.8, “SecureLogin Provisioning,” on page 31](#)
- ♦ [Section 3.9, “SecureLogin Deprovisioning,” on page 31](#)

3.1 Extending the LDAP Schema

When SecureLogin is deployed on eDirectory servers, a tool called `ndsschema.exe` is utilized to extend the eDirectory schema with a set of SecureLogin attributes that are used to store encrypted credentials, policies, etc. on Users and container objects. These attributes are:

- ♦ Prot:SSO Auth
- ♦ Prot:SSO Entry
- ♦ Prot:SSO Entry Checksum
- ♦ Prot:SSO Profile
- ♦ Prot:SSO Security Prefs
- ♦ Prot:SSO Security Prefs Checksum

These attributes are specific to eDirectory and are required in order for the SecureLogin product to function. The provisioning API provided in Identity Manager utilizes the LDAP namespace to perform its functions so that it can work with any SecureLogin credential store.

In order to provide LDAP mappings to the attributes listed above, a second tool provided with the SecureLogin product must be utilized. The tool name is `ldapschema.exe`, and it is used in eDirectory environments to provide the LDAP namespace mapping to the eDirectory attributes.

If these two tools have not been run, see “Installing” (http://www.novell.com/documentation/securelogin61/nsl61_installation_guide/data/b9idwvv.html) in the *Novell SecureLogin 6.1 Installation Guide*.

After running `ldapschema.exe`, verify the mappings by checking the LDAP Group attribute map in iManager.

- 1 In iManager, click *LDAP > LDAP Options*.
- 2 Select the LDAP Group associated with your eDirectory servers that host SecureLogin.
- 3 From the LDAP Group properties page, select the *Attribute Map* option and verify that the eDirectory attributes are correctly mapped:

eDirectory Attributes	LDAP Attributes
Prot:SSO Auth	protocom-SSO-Auth-Data
Prot:SSO Entry	protocom-SSO-Entries
Prot:SSO Entry Checksum	protocom-SSO-Entries-Checksum
Prot:SSO Profile	protocom-SSO-Profile
Prot:SSO Security Prefs	protocom-SSO-Security-Prefs
Prot:SSO Security Prefs Checksum	protocom-SSO-Security-Prefs-Checksum

- 4 After the schema is extended, proceed to [Section 3.2, “Determining Deployment Configuration Parameters for Novell SecureLogin,”](#) on page 16.

3.2 Determining Deployment Configuration Parameters for Novell SecureLogin

In order to provide the synchronization functionality described in the deployment scenario illustrated in [Figure 1-1, “Credential Provisioning with SecureLogin,”](#) on page 10, the first step is to gather all of the business process information related to the Identity Manager and SecureLogin environments. You can print the following table and use it as a worksheet to record the information.

Table 3-1 *Credential Provisioning Policies Worksheet for SecureLogin*

Configuration Information Needed	Information
1) Which applications will be configured for SecureLogin Single Sign-On provisioning?	
2) Verify that SecureLogin application definitions are preconfigured on the authentication server and are inheritable by new users provisioned to those systems.	
3) The DNS name or IP address of the SecureLogin repository server.	
4) The SSL LDAP port for the SecureLogin repository server.	
5) The fully qualified LDAP distinguished name of the administrator for the SecureLogin repository server.	
6) The password of the administrator for the SecureLogin repository server.	

Configuration Information Needed	Information
7) The full path and the name of the SSL certificate exported from the SecureLogin server. The certificate must be local to the Identity Manager server.	
8) Determine if one SecureLogin repository will be used by multiple drivers or if each driver will use a separate repository.	
9) The application ID for each SecureLogin application.	
10) List all required authentication keys for each application, such as, Username, Password, Client, and Language. They might be different for each application.	
11) Determine if any of the authentication key values can be set with a static value.	
12) For non-static values that are or can be different for each user, make a note of the source of the non-static information (event information or Identity Vault attribute values).	
13) If you are implementing SecureLogin provisioning on a driver that is also synchronizing a password to the target application, determine if the SecureLogin provisioning takes place before or after the password is set in the target application server.	
14) The name of the Driver object where the repository and application objects are to be stored. (Can be different drivers.)	
15) Determine the DN of the User objects for the target application.	
16) If you are implementing a SecureLogin passphrase, determine the passphrase question and answer.	Question: Answer:

3.2.1 Example Provisioning Configuration Data

Using the provisioning scenario in [Figure 1-1, “Credential Provisioning with SecureLogin,” on page 10](#), the following example data provisions a user’s SecureLogin credentials for the SAP Finance server for users in the Finance Active Directory authentication tree:

Table 3-2 Example Credential Provisioning Policies Worksheet for SecureLogin

Configuration Information Needed	Information
1) Which applications will be configured for SecureLogin Single Sign-On provisioning?	SAP Finance Application
2) Verify that SecureLogin application definitions are preconfigured on the authentication server and are inheritable by new users provisioned to those systems.	Verified

Configuration Information Needed	Information
3) The DNS name or IP address of the SecureLogin repository server.	151.150.191.5
4) The SSL LDAP port for the SecureLogin repository server.	636
5) The fully qualified LDAP distinguished name of the administrator for the SecureLogin repository server.	cn=admin,ou=prod,dc=testco,dc=.com
6) The password of the administrator for the SecureLogin repository server.	dixml
7) The full path and the name of the SSL certificate exported from the SecureLogin server. The certificate must be local to the Identity Manager server.	c:\novell\nds\FinanceAD.cer
8) Determine if one SecureLogin repository will be used by multiple drivers or if each driver will use a separate repository.	For this example, there is only one repository.
9) The application ID for each SecureLogin application.	SAP - 151.150.191.27
10) List all required authentication keys for each application, such as, Username, Password, Client, and Language. They might be different for each application.	SAP Client 010 Login Parameter Client SAP Client 010 Login Parameter Language SAP Client 010 Login Parameter Username SAP Client 010 Login Parameter Password
11) Determine if any of the authentication key values can be set with a static value.	SAP Client 010 Login Parameter Client:"010" SAP Client 010 Login Parameter Language: "EN"
12) For non-static values that are or can be different for each user, make a note of the source of the non-static information (event information or Identity Vault attribute values).	SAP Client 010 Login Parameter Username: Identity Vault attribute "sapUsername" SAP Client 010 Login Parameter Password: Event <password>
13) If you are implementing SecureLogin provisioning on a driver that is also synchronizing a password to the target application, determine if the SecureLogin provisioning takes place before or after the password is set in the target application server.	After
14) The name of the Driver object where the repository and application objects are to be stored. (Can be different drivers.)	SAP driver
15) Determine the DN of the User objects for the target application.	Identity Vault attribute "DirXML-ADContext"
16) If you are going to provision the SecureLogin passphrase, determine the passphrase question and answer.	Question: "Employee code?" Answer: Identity Vault attribute "workforceID"

Miscellaneous Environment Information:

- ◆ The Finance department AD tree serves as the SecureLogin repository for all Finance applications.

- ♦ All finance department provisioning drivers are in a driver set called Finance Drivers.
- ♦ The SAP user account must be deleted and the SecureLogin credentials for the SAP user account must be removed from the Active Directory user when the Identity Vault attribute “employeeStatus” is set to the value “I”.

After all of the configuration data has been determined, proceed to [Section 3.3, “Creating a Repository Object,”](#) on page 19.

3.3 Creating a Repository Object

Repository objects store static configuration information for SecureLogin. Repository information is independent from the applications that consume the application credentials. This information is applicable for all provisioning events regardless of the connected system (for example SAP, PeopleSoft, Notes, etc.). The repository object can be created in Designer or iManager.



- ♦ [Section 3.3.1, “Creating a Repository Object in Designer,”](#) on page 19
- ♦ [Section 3.3.2, “Creating a Repository Object in iManager,”](#) on page 20

3.3.1 Creating a Repository Object in Designer

The following is one of many methods you can use to create the repository object in Designer.

- 1 Right-click the driver object where you want to store the repository object in the outline view.
- 2 Click *New > Credential Repository* .
- 3 Specify a name for the repository object.
- 4 Select *NSLRepository.xml* to use the SecureLogin template.
Verify that the *Open the editor after creating the object* check box is selected.
- 5 Click *OK*.
- 6 Click *Yes*, in the file conflict window, to save the new repository object.
- 7 Use the following information to complete the creation of the Repository object.

Field	Description
SecureLogin Server Name or Address	Specify the DNS name or IP address of the Secure Login server. (See worksheet item 3).
SecureLogin Server SSL Port	Specify the SSL port for the SecureLogin server. (See worksheet item 4).
SecureLogin Server SSL Certificate Path	Specify the full path to the SSL certificate exported from the SecureLogin server. The path must include the certificate name and must be local to the Identity Manager server. (See worksheet item 7).
SecureLogin Administrator	Specify the fully qualified LDAP distinguished name of the SecureLogin administration. (See worksheet item 5).
SecureLogin Administrator Password	Specify the SecureLogin administrator’s password twice, then click <i>OK</i> to save the password. (See worksheet item 6).

- 8 Review the information, then click the *Save* icon  to save the information.
- 9 (Optional) If you want to create other configuration parameters for the repository object, click the *Add new item*  icon.
 - 9a Specify a name for the parameter.
 - 9b Specify a display name for the parameter.
 - 9c Specify a description of the parameter for your reference.
The parameter is stored as a string.

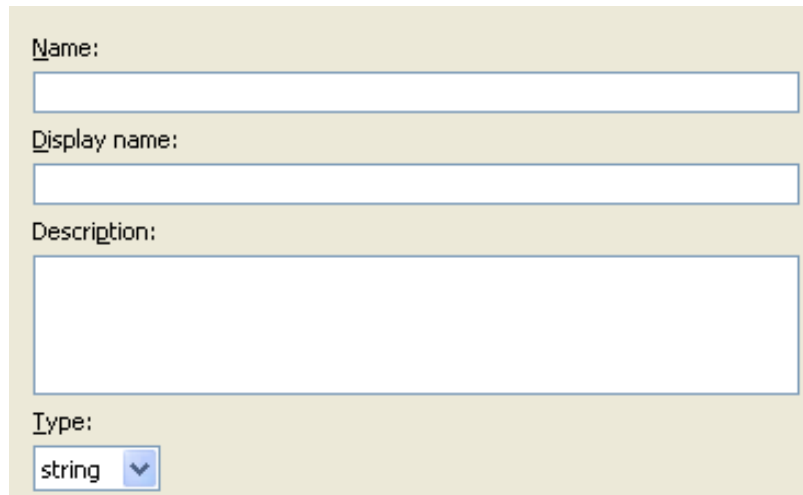

Name:

Display name:

Description:

Type:
 

- 9d Click *OK*.
- 9e Click the *Save* icon  to save the repository object.

After the repository object is created, proceed to [“Creating an Application Object”](#) on page 22.

3.3.2 Creating a Repository Object in iManager

- 1 In iManager, select *Credential Provisioning* > *Configuration*.
- 2 Browse to and select the Driver object where the repository object will be stored.

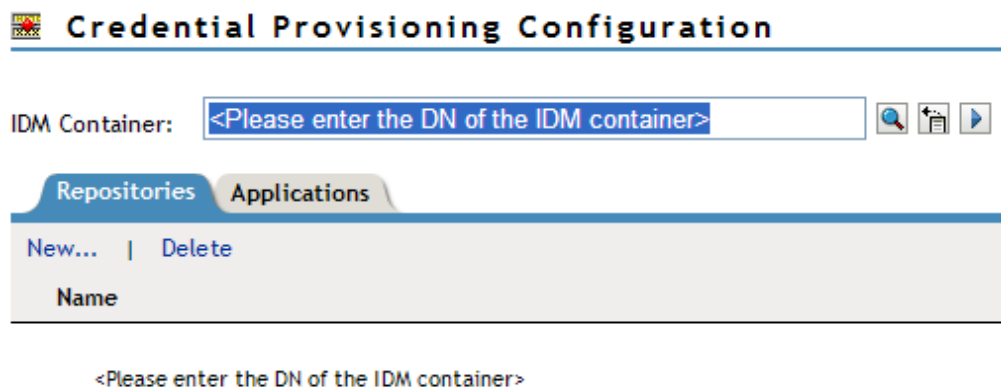

- 3 Click *New* to create a repository.

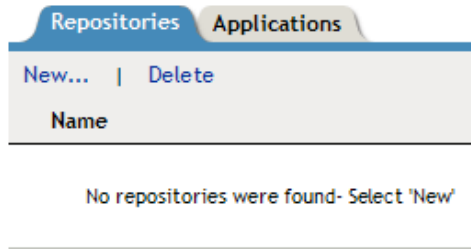

- 4 Specify a name for the repository object, then select *NSLRepository.xml* to use the SecureLogin template to create a repository.
- 5 Click *OK*.
- 6 Use the following information to complete the creation of the Repository object.

Field	Description
SecureLogin Server Name or Address	Specify the DNS name or IP address of the SecureLogin server. (See worksheet item 3).
SecureLogin Server SSL Port	Specify the SSL port for the SecureLogin server. (See worksheet item 4).
SecureLogin Server SSL Certificate Path	Specify the full path to the SSL certificate exported from the SecureLogin server. The path must include the certificate name and must be local to the Identity Manager server. (See worksheet item 7).
SecureLogin Administrator	Specify the fully qualified LDAP distinguished name of the SecureLogin administration. (See worksheet item 5).
SecureLogin Administrator Password	Specify the SecureLogin administrator's password twice, then click <i>OK</i> to save the password. (See worksheet item 6).

- 7 Review the values specified, then click *OK*.
- 8 (Optional) If you need to create other configuration parameters for the repository, click *New*.
 - 8a Specify a name for the parameter.
 - 8b Specify a display name for the parameter.
 - 8c Specify a description of the parameter for your reference.
The parameter is stored as a string.

Global Configuration Value Definition

Global Configuration Values are a means through which the behavior of an Identity Manager driver configuration can be changed without requiring any policy to be changed.

Name:

Display name:

Description:

Type:
string ▾

8d Click *OK*.

After the repository object is created, proceed to [“Creating an Application Object” on page 22](#).

3.4 Creating an Application Object

Application objects store application authentication parameter values for SecureLogin. Application information is specific to the applications that are consuming the application credential (for example, GroupWise client information or SAP database client information). The application objects can be created in Designer or iManager.

- ♦ [Section 3.4.1, “Creating an Application Object in Designer,” on page 22](#)
- ♦ [Section 3.4.2, “Creating an Application Object in iManager,” on page 24](#)

3.4.1 Creating an Application Object in Designer



The following is one of many methods you can use to create the application object in Designer.

- 1 In the Outline view, right-click the driver object where you want to store the application object.
- 2 Click *New > Credential Application* .
- 3 Specify a name for the application object.
- 4 Select *NSLApplication.xml* to use the SecureLogin template.
Verify that the *Open the editor after creating the object* check box is selected.
- 5 Click *OK*.
- 6 Click *Yes*, in the file conflict window, to save the new application object.
- 7 Specify the SecureLogin Application ID. (See worksheet item 9).

SecureLogin Application ID:

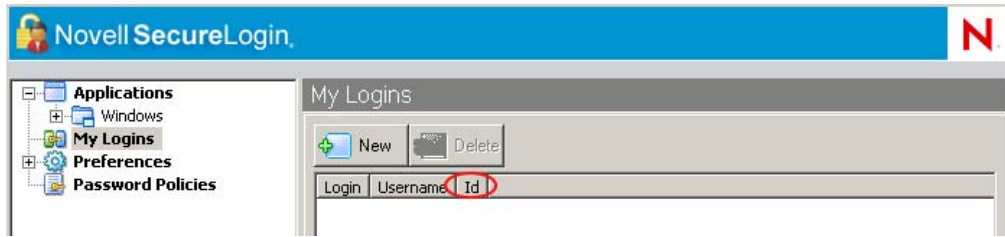
To find the application ID in SecureLogin, click *My Logins*. The application ID is stored in the *Id* field.



- 8 Click the *Save* icon  to save the application.
- 9 Click the *Add new item* icon  to add the authentication keys required for the application.

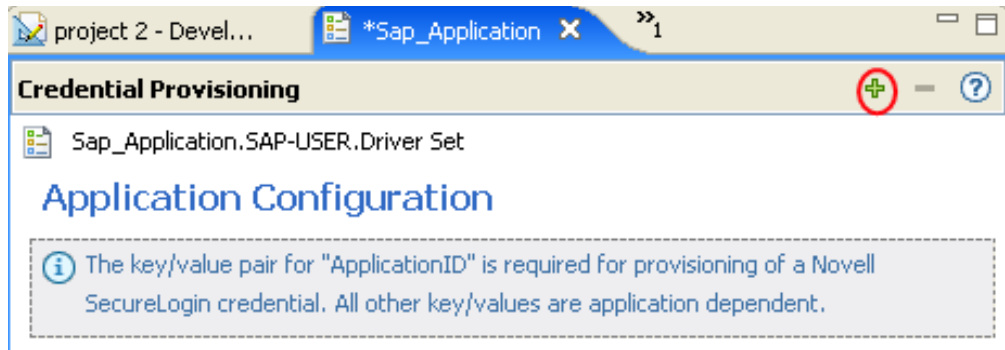

- 9a Specify a name for the authentication key.
- 9b Specify a display name for the authentication key.
- 9c Specify a description of the authentication key for your reference.
The authentication key is stored as a string.

Name:

Display name:

Description:

Type:
string 

- 9d Click *OK*.

9e Repeat [Step 9](#) for each new authentication key that needs to be entered.

To find the authentication key for your application, manually create a SecureLogin credential for a user in the application and have the user log in. After the user has logged in, the authentication key information is displayed under My Logins in the SecureLogin administration window.

10 Specify the authentication key value if it is a static value that is shared by all user credentials.

11 Click the Save icon  to save the application.

After the application object is created, proceed to [“Creating Credential Provisioning Policies” on page 26](#).

3.4.2 Creating an Application Object in iManager

1 In iManager, select *Credential Provisioning > Configuration*.

2 Browse to and select the Driver object where the application object will be stored.

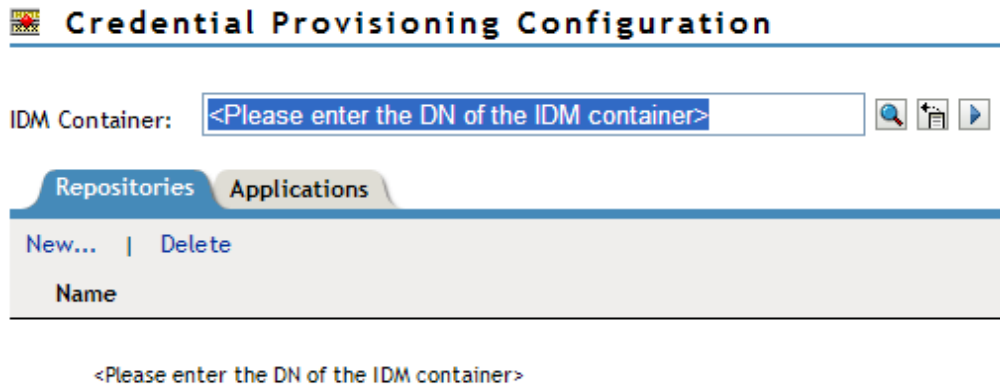

3 Select the *Applications* tab, then click *New*.

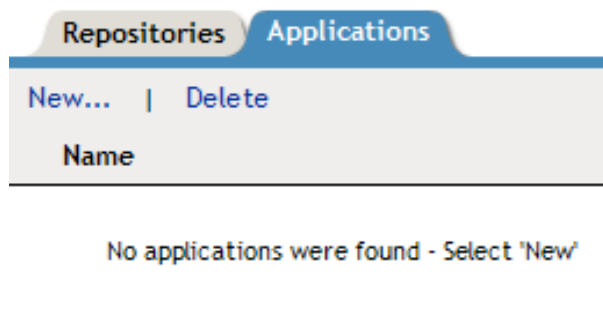

4 Specify a name for the application object.

5 Select *NSLApplication.xml* to use the SecureLogin template to create an application.

6 Click *OK*.

7 Specify the *SecureLogin Application ID*. (See [item worksheet 9](#)).

SecureLogin Application ID ⓘ

To find the application ID in SecureLogin, click *My Logins*. The application ID is stored in the *Id* field.

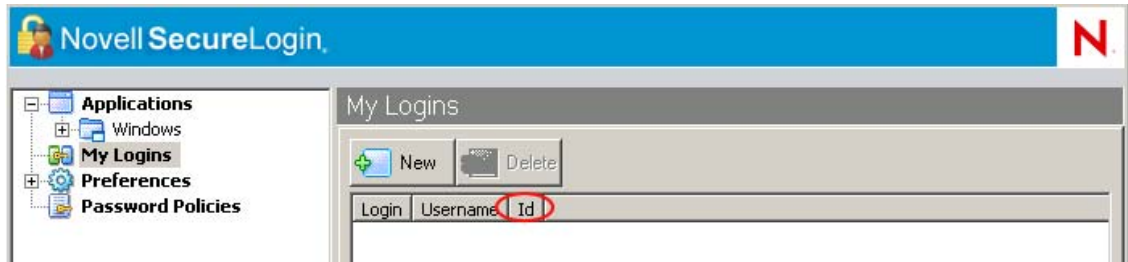

- 8 Click *New* to create an authentication key parameter. (See worksheet item 10).

Credential Provisioning Configuration

The key/value pair for "ApplicationID" is required for provisioning of a Novell SecureLogin credential. All other key/values are application dependent.

Application Configuration

New... | Delete

Display Name	Value

- 8a Specify a name for the authentication key.
- 8b Specify a display name for the authentication key.
- 8c Specify a description of the authentication key for your reference.

The authentication key is stored as string.

Global Configuration Value Definition

Global Configuration Values are a means through which the behavior of an Identity Manager driver configuration can be changed without requiring any policy to be changed.

Name:

Display name:

Description:

Type:

To find the authentication key for your application, manually create a SecureLogin credential for a user in the application and have the user log in. After the user has logged in, the authentication key information is displayed under *My Logins* in the SecureLogin administration window.

8d Click *OK*.

8e Specify the value of the authentication key, if it is static, then click *OK*.

Application Configuration	
New... Delete	
Display Name	Value
<input type="checkbox"/> SecureLogin Application ID ⓘ	SAP - 151.150.191.27
<input type="checkbox"/> <u>Client</u> ⓘ	010
<input type="checkbox"/> <u>Language</u> ⓘ	EN
<input type="checkbox"/> <u>Username</u> ⓘ	
<input type="checkbox"/> <u>Password</u> ⓘ	

After the application object is created, proceed to [“Creating Credential Provisioning Policies” on page 26](#).

3.5 Creating Credential Provisioning Policies

After the repository and application objects are created, policies need to be created to provision SecureLogin information. The policies can be created in Designer or iManager.

- ♦ [Section 3.5.1, “Creating Credential Provisioning Policies in Designer,” on page 26](#)
- ♦ [Section 3.5.2, “Creating Credential Provisioning Policies in iManager,” on page 28](#)

3.5.1 Creating Credential Provisioning Policies in Designer

The policies use the information stored in the repository and application objects.

- 1 In the Policy Builder, create a new policy.
- 2 (Optional) To clear the SSO credential, so objects can be deprovisioned, select the *clear SSO credential* action, then fill in the following fields:

Do 

Specify credential repository object DN: * 

Render browsed DN relative to policy

Specify target user DN: * 

[Populate the following from an application object](#)

Specify application credential ID: *

Specify login parameter strings: 

Specify Credential Repository Object DN: Browse to and select the repository object. (See worksheet item 8).

Specify Target User DN: Create the DN of the target users by using the Argument Builder. (See worksheet item 15).

Specify Application Credential ID: Specify the application ID. (See worksheet item 9).

Specify Login Parameter Strings: Launch the String Builder and enter each authentication key for the application. (See worksheet item 10).

- 3 (Optional) To set the SSO credential when a user object is created or when a password is modified, select the *set SSO credential* action, then fill in the following fields:

Do 

Specify credential repository object DN: * 

Render browsed DN relative to policy

Specify target user DN: * 

[Populate the following from an application object](#)

Specify application credential ID: *

Specify login parameter strings: 

Specify Credential Repository Object DN: Browse to and select the repository object. (See worksheet item 8).

Specify Target User DN: Create the DN of the target users by using the Argument Builder. (See worksheet item 15).

Specify Application Credential ID: Specify the application ID. (See worksheet item 9).

Specify Login Parameter Strings: Launch the String Builder and enter each authentication key for the application. (See worksheet item 10).

- 4 (Optional) To create a SecureLogin passphrase and answer for a user object when it is provisioned, select the *set SSO passphrase action*, then fill in the following fields:

Specify Credential Repository Object DN: Browse to and select the repository object. (See worksheet item 8).

Specify Target User DN: Create the DN of the target users by using the Argument Builder. (See worksheet item 15).

Question String: Specify the passphrase question. (See worksheet item 16).

Answer String: Specify the passphrase answer. (See worksheet item 16).

3.5.2 Creating Credential Provisioning Policies in iManager

The policies use the information stored in the repository and application objects.

- 1 In the Policy Builder, create a new policy.
- 2 (Optional) To clear the SSO credential, so objects can be deprovisioned, select the *clear SSO credential* action, then fill in the following fields:

Enter Credential Repository Object DN: Browse to and select the repository object. (See worksheet item 8).

Enter Target User DN: Create the DN of the target users by using the Argument Builder. (See worksheet item 15).

Enter Application Credential ID: Specify the application ID. (See worksheet item 9).

Enter Login Parameter Strings: Launch the String Builder and enter each authentication key for the application. (See worksheet item 10).

- 3 (Optional) To set the SSO credential when a user object is created or when a password is modified, select the *set SSO credential* action, then fill in the following fields:

Enter Credential Repository Object DN: Browse to and select the repository object. (See worksheet item 8).

Enter Target User DN: Create the DN of the target users by using the Argument Builder. (See worksheet item 15).

Enter Application Credential ID: Specify the application ID. (See worksheet item 9).

Enter Login Parameter Strings: Launch the String Builder and enter each authentication key for the application. (See worksheet item 10).

- 4 (Optional) To create a SecureLogin passphrase and answer for a user object when it is provisioned, select the *set SSO passphrase action*, then fill in the following fields:

Enter Credential Repository Object DN: Browse to and select the repository object. (See worksheet item 8).

Enter Target User DN: Create the DN of the target users by using the Argument Builder. (See worksheet item 15).

Enter Question and Answer Strings: Launch the String Builder and enter the passphrase question and answer. (See worksheet item 16).

3.6 Example Credential Provisioning Policies

The provisioning policies can be implemented and customized to meet the needs of your environment. The following example explains how to implement the policies for the scenario presented in [Figure 1-1, “Credential Provisioning with SecureLogin,” on page 10](#).

In the Finance scenario, SecureLogin provisioning occurs after a password is successfully set in SAP. Most of the necessary parameters are statically configured and available to all policies through the repository and application objects. However, there are non-static data parameters (`sapUsername`, `password`, `DirXML-ADContext`, and `workforceID`) that are available only after the SAP User Management driver `<add>` or `<modify-password>` commands complete and the `<output>` status

document is returned from the SAP User Management driver shim. The <output> document no longer contains any of the Subscriber channel operation attributes and the user context of the command is lost, thus preventing queries on the object. It is therefore necessary to do the following:

- ♦ Make sure the SAP User driver's Subscriber Create policy enforces the presence of the non-static data parameters.
- ♦ Cache the non-static parameters required for the provisioning operation prior to issuing the Subscriber command to the SAP User driver shim.
- ♦ Retrieve cached data for use in SecureLogin provisioning after the command completes successfully.

Sample policies are available in XML format on the Identity Manager media. The filenames are `SampleInputTransform.xml`, `SampleSubCommandTransform.xml`, and `SampleSubEventTransform.xml`. The files are found in the following directory, where `platform` is `linux`, `windows`, `aix`, or `solaris`:

```
platform\setup\utilities\cred_prov
```

The files are installed to the Identity Manager server, if Credential Provisioning Sample Policies is selected during the installation of the utilities. The sample policies are installed to the following locations, depending upon the platform:

- ♦ Windows: `C:\Novell\NDS\DirXMLUtilities`
- ♦ Linux: `/opt/novell/eDirectory/lib/dirxml/rules/credprov`

The sample policies provide a starting point to develop a policy that works for your environment.

3.7 Operation Data Caching

The mechanism that is available for required operation data caching is the <operation-data> element. Because you might need to provision the SecureLogin account from either an <add> or <modify-password> command, a logical place to implement the non-static data caching policy is in the Subscriber Command Transformation policy. The following example shows a typical SecureLogin Provisioning <operation-data> element:

```
<operation-data>
  <nsl-sync-data>
    <nsl-target-user-dn>
cn=GLCANYON,ou=finance,dc=prod,dc=testco,dc=com
    </nsl-target-user-dn>
    <nsl-app-username>GCANYON</nsl-app-username>
    <password><!-- content suppressed --></password>
    <nsl-passphrase-answer>50024222</nsl-passphrase-answer>
  </nsl-sync-data>
</operation-data>
```

In the sample Finance department scenario from [Figure 1-1, "Credential Provisioning with SecureLogin," on page 10](#), the following values are needed to populate the operation data payload:

- ♦ The <nsl-target-user-dn> element is populated with the value of the DirXML-ADContext attribute from the Identity Vault, which was set by the Active Directory driver. To ensure that the SAP User driver is notified when the value is set by the AD driver, make sure you add DirXML-ADContext to the Subscriber filter as a notify attribute.

- ♦ The `<nsl-app-username>` element is populated by the value of the `sapUsername` attribute which, for an `<add>` command, is generated by the Create policy of the SAP User driver and is therefore available as an operation attribute. With the SAP User driver, the SAP User name value is part of the association value. This means that for password modification events the names are parsed from the association.
- ♦ The password element is populated with the value of the `<password>` element in the `<add>` or `<modify-password>` command.
- ♦ The `<nsl-passphrase-answer>` element is populated with the value of the `workforceID` attribute from the Identity Vault, which was set by the SAP HR driver. Although this value should be set during initial provisioning to the Identity Vault, it is still a good practice to add `workforceID` to the Subscriber filter as a notify attribute.

3.8 SecureLogin Provisioning

In the provisioning scenario, the first available location from which the operation data can be retrieved and utilized for SecureLogin credential provisioning is in the driver's Input Transformation policy. In the sample scenario, three policies are implemented:

- ♦ Set SecureLogin Credentials after successful password synchronization.
- ♦ Set SecureLogin Passphrase and Answer
- ♦ Remove SecureLogin Credentials if Application User Deleted (Identity Vault object not deleted)

There is a sample policy in the `SampleInputTransform.xml` file that sets SecureLogin credentials after a successful password synchronization occurs. The file is located in the [cred_prov folder](#) on the Identity Manager media.

The Set SecureLogin Credentials policy needs to make sure the provisioning happens only if the returned command status is success and the previously set `<operation-data>` is present.

3.9 SecureLogin Deprovisioning

There are many scenarios that can utilize a policy in which a user account for a connected application is deleted and the Identity Vault account remains. In the Finance scenario, there is a requirement to delete the SAP User account and deprovision the SecureLogin credentials when the User's Identity Vault `employeeStatus` attribute value is set to "I". To handle this situation, the SAP User driver's Subscriber Event Transformation contains a policy to transform the modify attribute value into an object delete. Because the Active Directory account name is still needed after the `<delete>` command is completed, the `<operation-data>` event needs to be set on the `<delete>` command so it is available to the SecureLogin deprovisioning policy in the Input Transformation policy.

```
<operation-data>
  <nsl-sync-data>
    <nsl-target-user-dn>cn=GLCANYON,ou=finance,dc=prod,dc=testco,dc=com
  </nsl-target-user-dn>
</nsl-sync-data>
</operation-data>
```

The policy for transforming the `<modify>` event into a `<delete>` and creating this element is available in the sample Credential Provisioning policies in the `SampleSubEventTransform.xml` file. The file is located in the [cred_prov folder](#) on the Identity Manager media.

4 Managing Credential Provisioning





There are additional tasks you can perform to manage the Novell Credential Provisioning policies after they are implemented.

- ♦ [Section 4.1, “Managing the Repository and Application Objects,” on page 33](#)
- ♦ [Section 4.2, “Managing the Credential Provisioning Policies,” on page 34](#)

4.1 Managing the Repository and Application Objects







To manage repository and application objects (resource objects):

- 1 In the Outline view, right-click the resource object.
- 2 Select the desired task.

Option	Description
 Edit	Launches the editor for the resource object.
 Copy	Copies the selected resource object.
Export to Configuration File	Saves the resource object as a .xml file.
 Live > Deploy	Deploys the resource object into the Identity Vault.
 Live > Compare	Compares the resource object to the corresponding object in the Identity Vault.
 Delete	Deletes the selected resource object.
Properties	Lets you rename the selected resource object.

4.2 Managing the Credential Provisioning Policies

- 1 In the Outline view, right-click the policy.
- 2 Select the desired task.

Option	Description
 Edit	Launches the Policy Builder.
 Copy	Copies the selected policy.
 Save As	Saves a copy of the policy with another name.
 Simulate	Lets you test the policy in Designer before it is deployed into the Identity Vault.
Export to Configuration File	Saves the resource object as a .xml file.
 Live > Deploy	Deploys the policy into the Identity Vault.
 Live > Compare	Compares the policy to the corresponding object in the Identity Vault.
 Delete	Deletes the selected policy.
Properties	Lets you rename the selected policy.

II Implementing Credential Provisioning with Novell SecretStore

The following sections provide the concepts and instructions required to implement credential provisioning with SecretStore:

- ♦ [Chapter 5, “Overview,” on page 37](#)
- ♦ [Chapter 6, “Requirements,” on page 41](#)
- ♦ [Chapter 7, “Implementing Credential Provisioning,” on page 43](#)
- ♦ [Chapter 8, “Managing Credential Provisioning,” on page 59](#)

5 Overview

Novell Credential Provisioning allows you to provision application credentials to User objects in a Novell SecretStore repository. The capability to provision the Application Server and the User credentials as part of a standard Identity Manager provisioning scenario provides a much more secure and synchronized Web Single Sign-On experience for users.

This section contains the steps required to configure objects and policies in Identity Manager. It does not contain deployment and configuration information for any SecretStore components. For SecretStore documentation, see [Novell SecretStore 3.3.3 documentation \(http://www.novell.com/documentation/secretstore33/index.html\)](http://www.novell.com/documentation/secretstore33/index.html).

To implement Credential Provisioning with SecretStore requires a repository object, an application object, and creating policies. Repository and application objects store the SecretStore information so that Identity Manager can use it. The policies are used so that any driver can be enabled to use Credential Provisioning. It is also possible to configure the following options:

- Credential Provisioning can be provided by the Publisher channel, Subscriber channel, or both channels.
- SecretStore synchronization can occur as part of an application password synchronization or be triggered by some other event.
- Web Services credentials can be provisioned without provisioning accounts for the application.

You can use random password generation to set the passwords for user accounts on connected systems to further secure your Identity Management environment. For more information, see “[Password Generation](#)” in the *Identity Manager 4.0.2 Security Guide* for using random password generation.

[Figure 5-1](#) shows a typical, yet simple, scenario involving the provisioning of the Single Sign-On credentials for a new user in GroupWise. This department provisions new users into the Identity Vault via a SAP HR system and Identity Manager. Depending on organizational information, the user is then provisioned into a department authentication tree implemented on eDirectory. This is where new users authenticate to the network, and is also the repository of GroupWise security credentials that Novell iChain or Novell Access Manager utilizes to provide secure Single Sign-On functionality from outside the company firewall. As users are subsequently provisioned by Identity Manager to GroupWise, the credentials for those systems are synchronized to their SecretStore attributes in the authentication tree.

Figure 5-1 Credential Provisioning with SecretStore

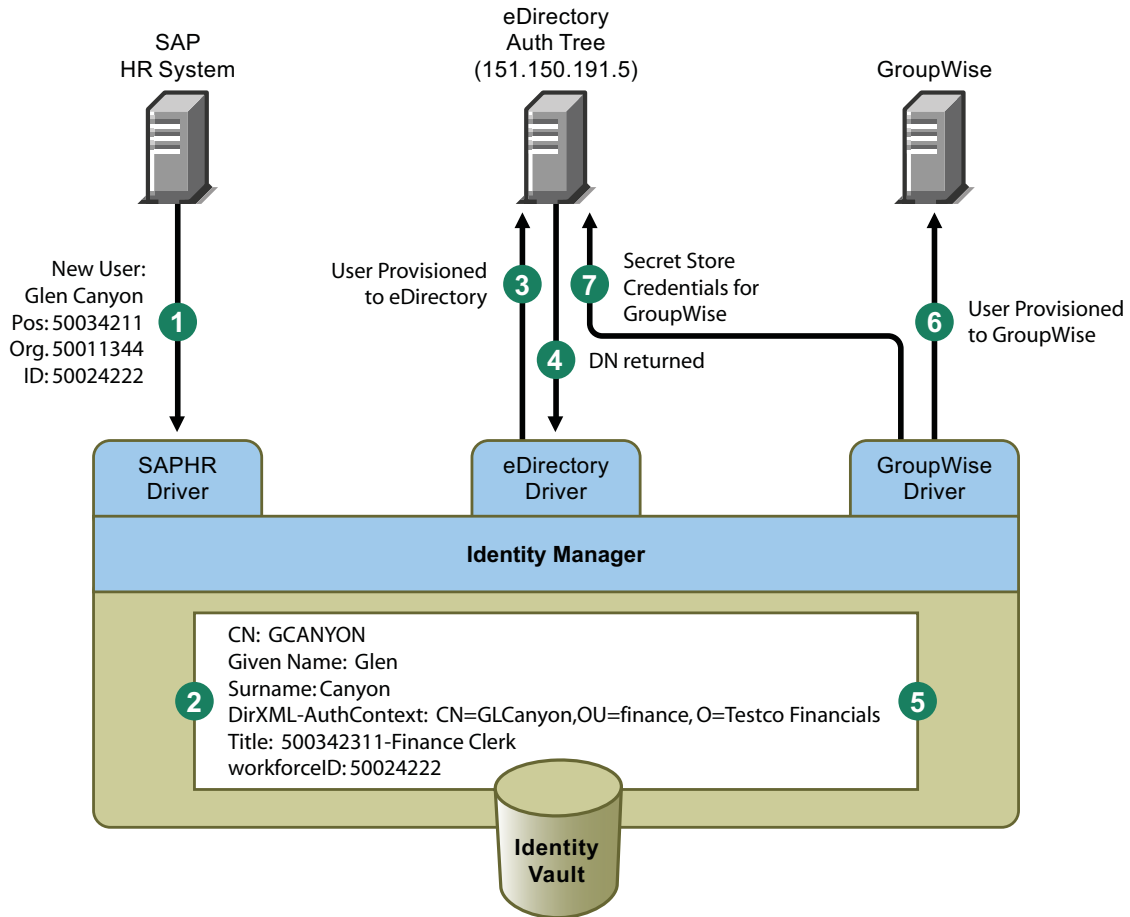

Figure 5-1 illustrates the following provisioning steps:

1. The SAP HR system publishes the data for a newly hired user named Glen Canyon. The Identity Manager SAP HR driver processes this data.
2. A new User object is created in the Identity Vault with a CN value of GCANYON and a workforceID value of 50024222. Because this user is assigned to the Finance organization of his company, he needs to authenticate to the Finance Department eDirectory server. The Identity Manager eDirectory driver that synchronizes that domain now uses the Identity Vault information.
3. Glen is provisioned to the Finance department eDirectory server.
4. The driver is configured to obtain Glen's fully distinguished LDAP name: CN=GLCanyon,OU=finance,O=Testco Financials.
5. The LDAP name is placed into the DirXML-AuthContext (extension of User object, copy of DirXML-ADContext) attribute of the GCANYON user in the Identity Vault.
Now that the required attributes are available in the Identity Vault, the GroupWise driver processes the attributes of the GCANYON object.
6. Because Glen is in the Finance organization, the driver provisions a GroupWise account for GCANYON on the Finance Departments GroupWise domain server.
7. After the account creation is successful, the GroupWise driver policies provision Glen's GroupWise authentication credentials to the secret store of his eDirectory user account.

When Glen authenticates to his company's Web site from the Internet, an iChain server can use the SecretStore credentials to form-fill his authentication to his secure GroupWise e-mail account, eliminating the need for him to enter his GroupWise credentials and also providing additional security for the company's resources.

6 Requirements

In order to use credential provisioning with SecretStore, the following items must be in place:

- ♦ Identity Manager 3.6 or later
- ♦ `jsso.jar`, `idmcp.jar`, and `jnet.jar` must reside in the standard location for Identity Manager Java libraries.
- ♦ Novell SecretStore 3.3 or above

7 Implementing Credential Provisioning

The implementation of Novell Credential Provisioning with Novell SecretStore is very customizable. The steps to implement it are different depending upon the platform SecretStore is installed on, the applications that are provisioned, and which Identity Manager drivers are involved.

To implement Credential Provisioning with SecretStore:

- ♦ [Section 7.1, “Determining Deployment Configuration Parameters,” on page 43](#)
- ♦ [Section 7.2, “Creating a Repository Object,” on page 46](#)
- ♦ [Section 7.3, “Creating an Application Object,” on page 50](#)
- ♦ [Section 7.4, “Creating Credential Provisioning Policies,” on page 54](#)
- ♦ [Section 7.5, “Example Credential Provisioning Policies,” on page 56](#)
- ♦ [Section 7.6, “Operation Data Caching,” on page 57](#)
- ♦ [Section 7.7, “SecretStore Provisioning,” on page 58](#)
- ♦ [Section 7.8, “SecretStore Deprovisioning,” on page 58](#)

7.1 Determining Deployment Configuration Parameters

In order to provide the synchronization functionality described in the deployment scenario illustrated in [Figure 5-1, “Credential Provisioning with SecretStore,” on page 38](#), the first step is to gather all of the business process information related to the Identity Manager and SecretStore environments. You can print the following table and use it as a worksheet to record the information.

Table 7-1 *Credential Provisioning Policies Worksheet for SecretStore*

Configuration Information Needed	Information
1) Which applications will be configured for Web Single Sign-On provisioning?	
2) The DNS name or IP address of the SecretStore repository server.	
3) The SSL LDAP port for the SecretStore repository server.	
4) The fully qualified LDAP distinguished name of the administrator for the SecretStore repository server.	
5) The password of the administrator for the SecretStore repository server.	

Configuration Information Needed	Information
6) The full path and the name of the SSL certificate exported from the SecretStore server. The certificate must be local to the Identity Manager server.	
7) Determine if SecretStore repositories will be used by multiple drivers or if each driver will use a separate repository.	
8) Record the type of SecretStore secret that is being used. There are two supported types of secrets: <ul style="list-style-type: none"> ◆ A: Application Secret (SS_App: prefix) ◆ C: Credential Set Secret (SS_CredSet: prefix) 	
9) The application ID or Credential Set name for each provisioned application.	
10) List all required authentication keys for each application, such as Username and Password. They might be different for each application.	
11) Determine if any of the authentication key values can be set with a static value.	
12) For non-static values that are or can be different for each user, make a note of the source of the non-static information (event information or Identity Vault attribute values.)	
13) If you are implementing SecretStore provisioning on a driver that is also synchronizing a password to the target application, determine if the SecretStore provisioning takes place before or after the password is set in the target application server.	
14) The name of the Driver object where the repository and application objects are to be stored. (Can be different drivers.)	
15) Determine the DN of the User objects for the target application.	

7.1.1 Example Provisioning Configuration Data

Using the provisioning scenario in [Figure 5-1, “Credential Provisioning with SecretStore,” on page 38](#), the following example data provisions a user’s SecretStore credentials for the Finance department’s GroupWise domain server onto users in the Finance eDirectory authentication tree:

Table 7-2 Example Credential Provisioning Policies Worksheet for SecretStore

Configuration Information Needed	Information
1) Which applications will be configured for Web Single Sign-On provisioning?	GroupWise

Configuration Information Needed	Information
2) The DNS name or IP address of the SecretStore repository server.	151.150.191.5
3) The SSL LDAP port for the SecretStore repository server.	636
4) The fully qualified LDAP distinguished name of the administrator for the SecretStore repository server.	cn=admin,ou=finance,o=Tesetco Financials
5) The password of the administrator for the SecretStore repository server.	dixml
6) The full path and the name of the SSL certificate exported from the SecretStore server. The certificate must be local to the Identity Manager server.	c:\novell\nds\FinanceAD.cer
7) Determine if SecretStore repositories will be used by multiple drivers or if each driver will use a separate repository.	For this example, there is only one repository.
8) Record the type of SecretStore secret that is being used.	
There are two supported types of secrets:	
<ul style="list-style-type: none"> ◆ A: Application Secret (SS_App: prefix) ◆ C: Credential Set Secret (SS_CredSet: prex) 	
9) The application ID or Credential Set name for each provisioned application.	GroupWise_Credentials
10) List all required authentication keys for each application, such as Username and Password. They might be different for each application.	Username Password
11) Determine if any of the authentication key values can be set with a static value.	No static information for this scenario.
12) For non-static values that are or can be different for each user, make a note of the source of the non-static information (event information or Identity Vault attribute values.)	Username: Identity Vault attribute "CN" Password: Event <password>
13) If you are implementing SecretStore provisioning on a driver that is also synchronizing a password to the target application, determine if the SecretStore provisioning takes place before or after the password is set in the target application server.	After
14) The name of the Driver object where the repository and application objects are to be stored. (Can be different drivers.)	GroupWise-Finance driver
15) Determine the DN of the User objects for the target application.	Identity Vault attribute "DirXML-ADContext"

Miscellaneous Environment Information:

- ◆ The Finance department eDirectory tree serves as the SecretStore repository for all Finance applications.

- ♦ All finance department provisioning drivers are in a driver set called Finance Drivers.
- ♦ The GroupWise account must be deleted and the SecretStore credentials for the GroupWise user account must be removed from the eDirectory user when the Identity Vault attribute `employeeStatus` is set to the value "I".

As can be seen from the data gathered, the SecretStore repository information is global for all drivers that provision Finance department applications. In addition, all provisioning information can be statically configured, with the exception of the GroupWise login parameters Username, Password, and Target User DN.

After all of the configuration data has been determined, proceed to [Section 7.2, "Creating a Repository Object,"](#) on page 46.

7.2 Creating a Repository Object

Repository objects store static configuration information for SecretStore. Repository information is independent from the applications that consume the application credentials. This information is applicable for all provisioning events regardless of the connected system (for example SAP, PeopleSoft, Notes, etc.) The repository object can be created in Designer or iManager.



- ♦ [Section 7.2.1, "Creating a Repository Object in Designer,"](#) on page 46
- ♦ [Section 7.2.2, "Creating a Repository Object in iManager,"](#) on page 48

7.2.1 Creating a Repository Object in Designer

The following is one of many methods you can use to create the repository object in Designer.

- 1 In the outline view, right-click the driver object where you want to store the repository object.
- 2 Click *New > Credential Repository* .
- 3 Specify a name for the repository object.
- 4 Select *NSSRepository.xml* to use the SecretStore template.
Verify that the *Open the editor after creating the object* check box is selected.
- 5 Click *OK*.
- 6 Click *Yes*, in the conflict window, to save the new repository object.
- 7 Use the following information to complete the creation of the repository object.

Field	Description
SecretStore Server Name or Address	Specify the DNS name or IP address of the SecretStore server. (See worksheet item 2).
SecretStore Server SSL Port	Specify the SSL port for the SecretStore server. (See worksheet item 3).
SecretStore Server SSL Certificate Path	Specify the full path to the SSL certificate exported from the SecretStore server. The path must include the certificate name and must be local to the Identity Manager server. (See worksheet item 6). Refer to the Certificate Server (http://www.novell.com/documentation/crt33) documentation for the information on how to export the SSL certificate.
SecretStore Administrator	Specify the fully qualified LDAP distinguished name or the SecretStore administrator. (See worksheet item 4).
SecretStore Administrator Passwords	Specify the SecretStore administrator's password twice, then click OK . (See worksheet item 5).

- 8 Review the information, then click the *Save* icon  to save the information.
- 9 (Optional) If you want to create other configuration parameters for the repository object, click the *Add new item* icon .
 - 9a Specify a name for the parameter.
 - 9b Specify a display name for the parameter.
 - 9c Specify a description of the parameter for your reference.
The parameter is stored as a string.

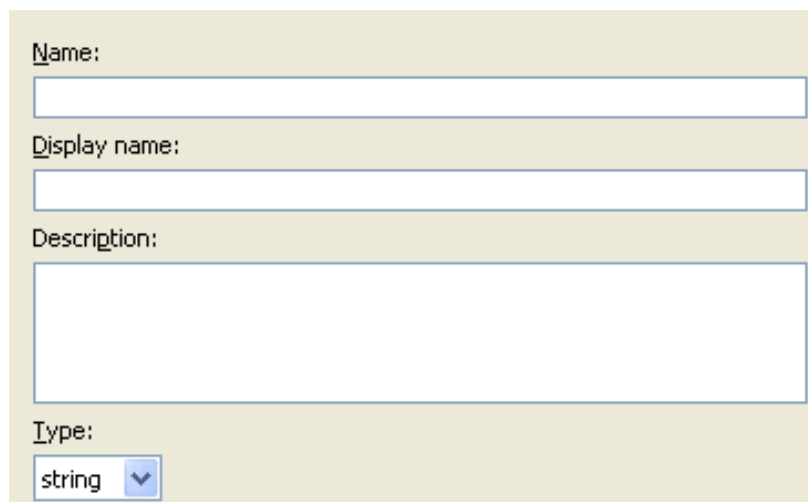

The screenshot shows a configuration form with the following fields:

- Name:** A text input field.
- Display name:** A text input field.
- Description:** A larger text input area.
- Type:** A dropdown menu currently showing "string".

- 9d Click **OK**.
- 9e Click the *Save* icon  to save the repository object.

After the repository object is created, proceed to [“Creating an Application Object” on page 22](#).

7.2.2 Creating a Repository Object in iManager

- 1 In iManager, select *Credential Provisioning > Configuration*.
- 2 Browse to and select the Driver object where the repository object will be stored.

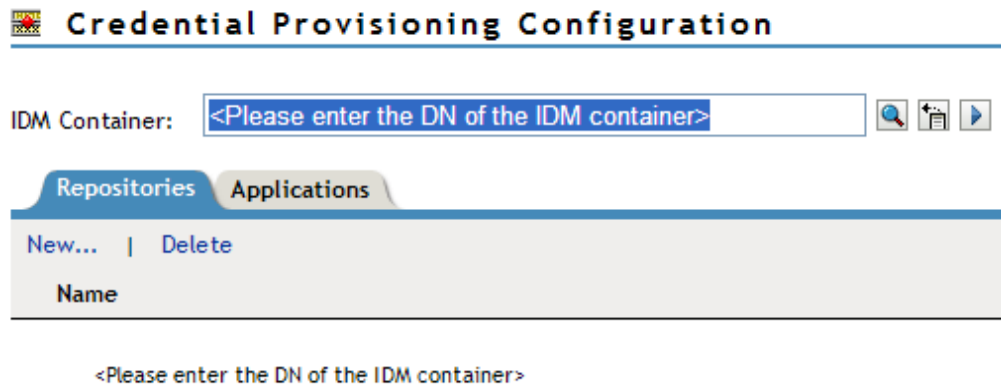

- 3 Click *New* to create a repository.

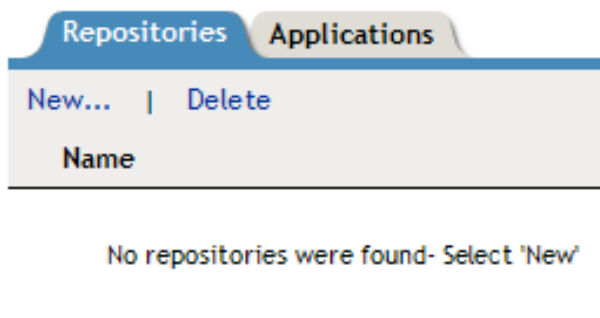

- 4 Specify a name for the repository object.
- 5 Select *NSSRepository.xml* to use the SecretStore template to create a repository.

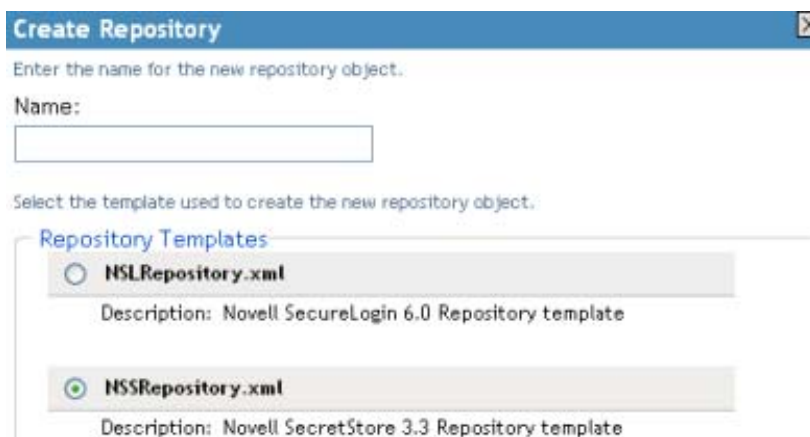

- 6 Click *OK*.
- 7 Use the following information to complete the creation of the repository object.

Field	Description
SecretStore Server Name or Address	Specify the DNS name or IP address of the SecretStore server. (See worksheet item 2).
SecretStore Server SSL Port	Specify the SSL port for the SecretStore server. (See worksheet item 3).
SecretStore Server SSL Certificate Path	Specify the full path to the SSL certificate exported from the SecretStore server. The path must include the certificate name and must be local to the Identity Manager server. (See worksheet item 6). Refer to the Certificate Server Certificate Server (http://www.novell.com/documentation/crt33) documentation for the information on how to export the SSL certificate.
SecretStore Administrator	Specify the fully qualified LDAP distinguished name or the SecretStore administrator. (See worksheet item 4).
SecretStore Administrator Passwords	Specify the SecretStore administrator's password twice, then click <i>OK</i> . (See worksheet item 5).

8 Review the values specified, then click *OK*.

9 (Optional) If you want to create other configuration parameters for the repository object, click *New*.

The example information is from the scenario in [Figure 5-1, "Credential Provisioning with SecretStore,"](#) on page 38.

9a Specify a name for the parameter.

9b Specify a display name for the parameter.

9c Specify a description of the parameter for your reference.

The parameter is stored as a string.

Global Configuration Value Definition

Global Configuration Values are a means through which the behavior of an Identity Manager driver configuration can be changed without requiring any policy to be changed.

Name:

Display name:

Description:

Type:
string ▾

9d Click *OK*.

After the repository object is created, proceed to [“Creating an Application Object” on page 22](#).

7.3 Creating an Application Object

Applications store static configuration parameter values for SecretStore. Application information is specific to the applications that are consuming the application credential (for example, GroupWise client information or SAP database client information). The application objects can be created in Designer or iManager.



- ♦ [Section 7.3.1, “Creating an Application Object in Designer,” on page 50](#)
- ♦ [Section 7.3.2, “Creating an Application Object in iManager,” on page 52](#)

7.3.1 Creating an Application Object in Designer

The following is one of many methods you can use to create the application in Designer.

- 1 In the Outline view, right-click the driver object where you want to store the application object.
- 2 Click *New > Credential Application* .
- 3 Specify a name for the application object.
- 4 Select *NSSApplication.xml* to use the SecretStore template.
Verify that the *Open the editor after creating the object* check box is selected.
- 5 Click *OK*.
- 6 Click *Yes*, in the conflict window, to save the new application object.
- 7 Use the following information to complete the creation of the application object.

Field	Description
SecretStore Application ID	Specify the SecretStore Application ID. (See worksheet item 9).
SecretStore Secret Type	Select the <i>SecretStore Secret Type</i> . (See worksheet item 8).
SecretStore Shared Secret Type	Select the <i>SecretStore Shared Secret Type</i> . (See worksheet item 7).
Use Enhanced Protection Flag	Select whether the <i>SecretStore Use Enhanced Protection Flag</i> is <i>Disabled</i> or <i>Enabled</i> .
Enhanced Protection Password	If the <i>Enhanced Protection Flag</i> is enabled, set the enhanced protection password twice.

- 8 Click the *Save* icon  to save the application.
- 9 Click the *Add new item* icon  to add the authentication keys required for the application.
 - 9a Specify a name for the authentication key.
 - 9b Specify a display name for the authentication key.
 - 9c Specify a description of the authentication key for your reference.
The authentication key is stored as a string.

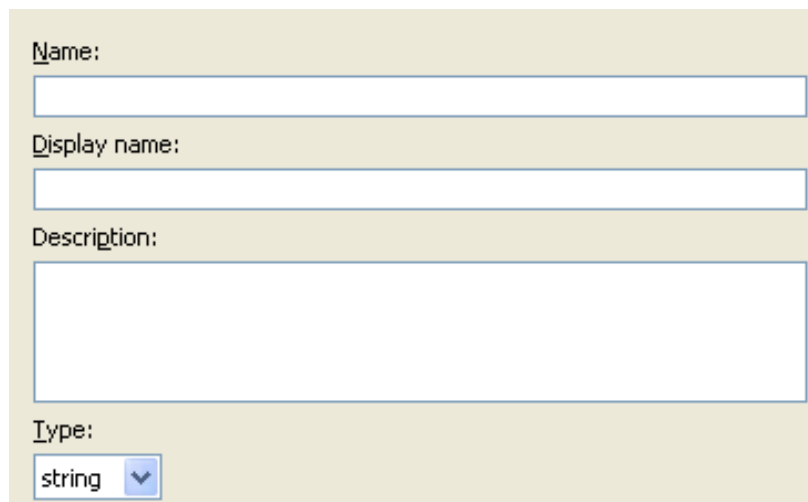

The screenshot shows a form with the following fields:

- Name:** A text input field.
- Display name:** A text input field.
- Description:** A larger text input field.
- Type:** A dropdown menu with "string" selected.

- 9d Click *OK*.
- 9e Repeat [Step 9](#) for each new authentication key that needs to be entered.
- 10 Specify the authentication key value, if it is a static value that is shared by all user credentials.
- 11 Click the *Save* icon  to save the application.

After the application object is created, proceed to [Section 7.4, "Creating Credential Provisioning Policies,"](#) on page 54.

7.3.2 Creating an Application Object in iManager

- 1 In iManager, select *Credential Provisioning > Configuration*.
- 2 Browse to and select the Driver object where the application object will be stored, then click *OK*.

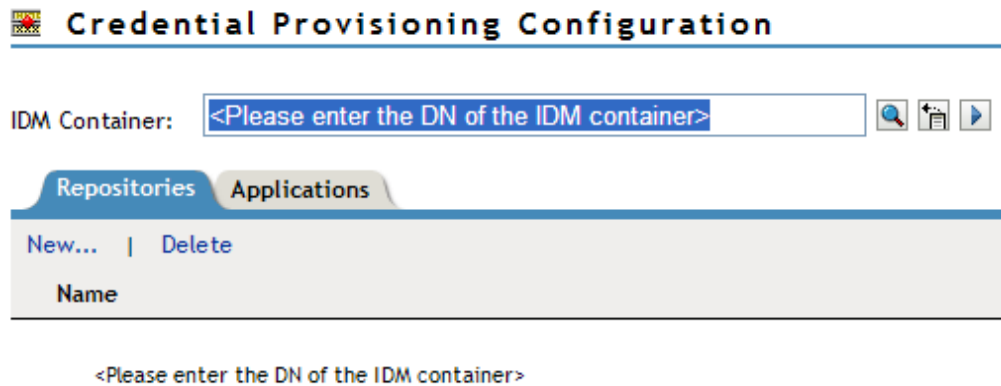

- 3 Select the *Applications* tab, then click *New*.

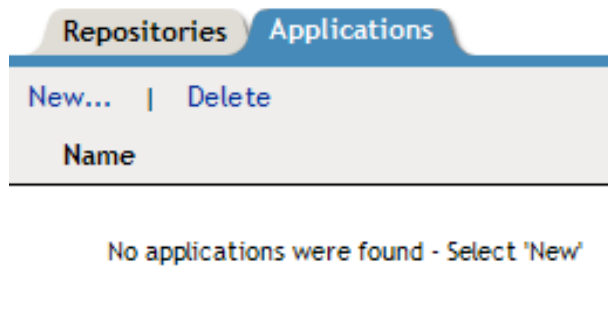

- 4 Specify a name for the application object
- 5 Select *NSSApplication.xml* to use the SecretStore template to create an application.
- 6 Click *OK*.
- 7 Use the following information to complete the creation of the application object.

Field	Description
SecretStore Application ID	Specify the SecretStore Application ID. (See worksheet item 9).
SecretStore Secret Type	Select the <i>SecretStore Secret Type</i> . (See worksheet item 8).
SecretStore Shared Secret Type	Select the <i>SecretStore Shared Secret Type</i> . (See worksheet item 7).
Use Enhanced Protection Flag	Select whether the <i>SecretStore Use Enhanced Protection Flase is Disabled</i> or <i>Enabled</i> .
Enhanced Protection Password	If the <i>Enhanced Protection Flag</i> is enabled, set the enhanced protection password twice.

- 8 Click *New* to create an authentication key that the application requires. (See worksheet item 10).
- 8a Specify a name for the authentication key.
 - 8b Specify a display name for the authentication key.
 - 8c Specify a description of the authentication key for your reference.

The authentication key is stored as a string.

 **Global Configuration Value Definition**

Global Configuration Values are a means through which the behavior of an Identity Manager driver configuration can be changed without requiring any policy to be changed.

Name:

Display name:

Description:

Type:
string 

- 8d Click *OK*.
- 8e Repeat [Step 8](#) for each authentication key that the application requires.

- 9 Specify the value of the authentication key, if it is static, then click *OK*.

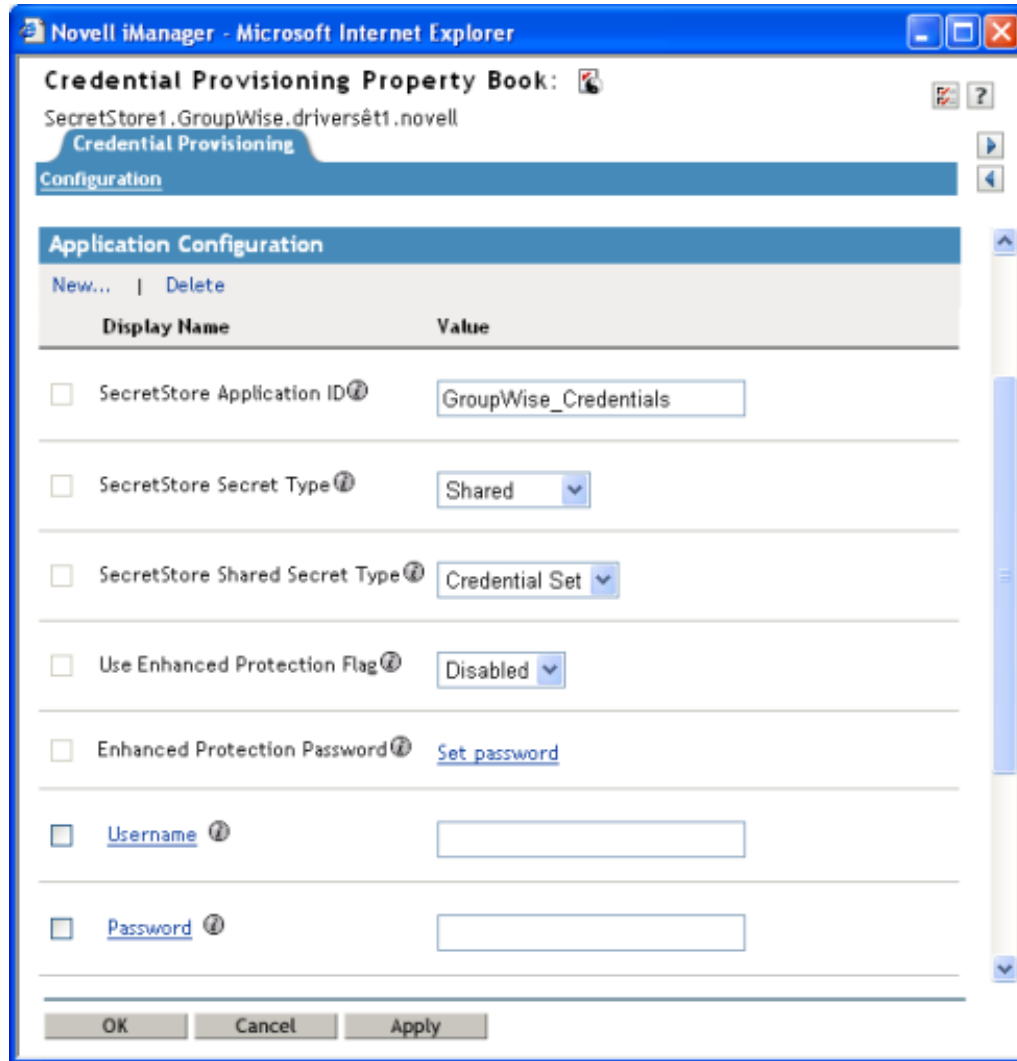

After the application object is created, proceed to [Section 7.4, "Creating Credential Provisioning Policies,"](#) on page 54.

7.4 Creating Credential Provisioning Policies

After the repository and application objects are created, policies need to be created to provision SecretStore information. The policies can be created in Designer or iManager.

7.4.1 Creating Credential Provisioning Policies in Designer

The policies use the information stored in the repository and application objects.

- 1 In the Policy Builder, create a new policy.
- 2 (Optional) To clear the SSO credential, so objects can be deprovisioned, select the *clear SSO credential* action, then fill in the following fields:

Do 

Specify credential repository object DN: * 

Render browsed DN relative to policy

Specify target user DN: * 

[Populate the following from an application object](#)

Specify application credential ID: *

Specify login parameter strings: 

Specify Credential Repository Object DN: Browse to and select the repository object. (See worksheet item 8).

Specify Target User DN: Create the DN of the target users by using the Argument Builder. (See worksheet item 15).

Specify Application Credential ID: Specify the application ID. (See worksheet item 9).

Specify Login Parameter Strings: Launch the String Builder and enter each authentication key for the application. (See worksheet item 10).

- 3 (Optional) To set the SSO credential when a user object is created or when a password is modified, select the *set SSO credential* action, then fill in the following fields:

Do 

Specify credential repository object DN: * 

Render browsed DN relative to policy

Specify target user DN: * 

[Populate the following from an application object](#)

Specify application credential ID: *

Specify login parameter strings: 

Specify Credential Repository Object DN: Browse to and select the repository object. (See worksheet item 8).

Specify Target User DN: Create the DN of the target users by using the Argument Builder. (See worksheet item 15).

Specify Application Credential ID: Specify the application ID. (See worksheet item 9).

Specify Login Parameter Strings: Launch the String Builder and enter each authentication key for the application. (See worksheet item 10).

7.4.2 Configuring Credential Provisioning Policies in iManager

The policies use the information stored in the repository and application objects.

- 1 In the Policy Builder, create a new policy.
- 2 (Optional) To clear the SSO credential, so objects can be deprovisioned, select the *clear SSO credential* action, then fill in the following fields:

Enter Credential Repository Object DN: Browse to and select the repository object. (See worksheet item 8).

Enter Target User DN: Create the DN of the target users by using the Argument Builder. (See worksheet item 15).

Enter Application Credential ID: Specify the application ID. (See worksheet item 9).

Enter Login Parameter Strings: Launch the String Builder and enter each authentication key for the application. (See worksheet item 10).

- 3 (Optional) To set the SSO credential when a user object is created or when a password is modified, select the *set SSO credential* action, then fill in the following fields:

Enter Credential Repository Object DN: Browse to and select the repository object. (See worksheet item 8).

Enter Target User DN: Create the DN of the target users by using the Argument Builder. (See worksheet item 15).

Enter Application Credential ID: Specify the application ID. (See worksheet item 9).

Enter Login Parameter Strings: Launch the String Builder and enter each authentication key for the application. (See worksheet item 10).

7.5 Example Credential Provisioning Policies

The credential provisioning policies can be implemented and customized to meet the needs of your environment. The following example explains how to implement the policies for the scenario presented in [Figure 5-1, "Credential Provisioning with SecretStore," on page 38](#).

In the Finance scenario, SecretStore provisioning occurs after a password is successfully set in GroupWise. Most of the necessary parameters are statically configured and available to all policies through the repository and application objects. However, there are non-static data parameters (CN, password, and DirXML-ADContext) that are available only after the GroupWise user `<add>` or `<modify-password>` commands complete and the `<output>` document is returned from the

GroupWise driver shim. The `<output>` document no longer contains any of the Subscriber operation attributes and the User context of the command is lost, thus preventing queries on the object. It is therefore necessary to do the following:

- ♦ Make sure the GroupWise driver's Subscriber Create policy enforces the presence of the non-static data parameters.
- ♦ Cache the non-static parameters required for the provisioning operation prior to issuing the Subscriber command to the GroupWise driver shim.
- ♦ Retrieve cached data for use in SecretStore provisioning after the command completes successfully.

Sample policies are available in XML format on the Identity Manager media. The filenames are `SampleInputTransform.xml`, `SampleSubCommandTransform.xml`, and `SampleSubEventTransform.xml`. The files are found in the following directory, where `platform` is `linux`, `windows`, `aix`, or `solaris`:

```
platform\setup\utilities\cred_prov
```

The files are installed to the Identity Manager server, if Credential Provisioning Sample Policies is selected during the installation of the utilities. The sample policies are installed to the following locations, depending upon the platform:

- ♦ Windows: `C:\Novell\NDS\DirXMLUtilities`
- ♦ Linux: `/opt/novell/eDirectory/lib/dirxml/rules/credprov`

The sample policies provide a starting point to develop a policy that works for your environment.

7.6 Operation Data Caching

The mechanism that is available for required operation data caching required is the `<operation-data>` element. Because you might need to provision the SecretStore account from either an `<add>` or `<modify-password>` command, a logical place to implement the non-static data caching policy is in the Subscriber Command Transformation policy. The following example shows a typical SecretStore Provisioning element:

```
<operation-data>
  <nss-sync-data>
    <nss-target-user-dn      cn=GLCANYON,ou=finance,o=Testco
Financials
    </nss-target-user-dn>
    <nss-app-username>GCANYON</nss-app-username>
    <password><!-- content suppressed --></password>
    <nss-passphrase-answer>50024222</nss-passphrase-answer>
  </nss-sync-data>
</operation-data>
```

In the sample Finance department scenario from [Figure 5-1, "Credential Provisioning with SecretStore," on page 38](#), the following values are needed to populate the operation data payload:

- ♦ The `<nss-target-user-dn>` element is populated with the value of the DirXML-ADContext attribute from the Identity Vault, which was set by the eDirectory driver. To ensure that the GroupWise driver is notified when the value is set by the eDirectory driver, make sure you add DirXML-ADContext to the Subscriber filter as a notify attribute.

- ♦ The <nss-app-username> element is populated by the value of the CN attribute in the Identity Vault.
- ♦ The password element is populated with the value of the <password> element in the <add> or <modify-password> command.

7.7 SecretStore Provisioning

In the sample scenario, the first available location from which the operation data can be retrieved and utilized for SecretStore credential provisioning is in the driver's Input Transformation policy. In the sample scenario, two policies are implemented:

- ♦ Set SecretStore Credentials after successful password synchronization
- ♦ Remove SecretStore Credentials if Application User Deleted (Identity Vault object not deleted)

There is a sample policy in the `SampleInputTransform.xml` file that sets the SecretStore credentials after a successful password synchronization occurs. The file is located in the [cred_prov folder](#) in the utilities directory on the Identity Manager media.

The Set SecretStore Credentials policy needs to make sure the provisioning happens only if the returned command status is Success and the previously set <operation-data> is present.

7.8 SecretStore Deprovisioning

There are many scenarios that can utilize a policy in which a user account for a connected application is deleted and the Identity Vault account remains. In the Finance scenario, there is a requirement to delete the GroupWise account and deprovision the SecretStore credentials when the user's Identity Vault employeeStatus attribute value is set to "I". To handle this situation, the GroupWise driver's Subscriber Event Transformation contains a policy to transform the modify attribute value into an object delete. Because the eDirectory account name is still needed after the <delete> command is completed, the <operation-data> event needs to be set on the <delete> command so it is available to the SecretStore deprovisioning policy in the Input Transformation policy.

```
<operation-data>
  <nss-sync-data>
    <nss-target-user-dn>cn=GLCANYON,ou=finance,o=Testco Financials
  </nss-target-user-dn>
</nss-sync-data>
</operation-data>
```

The policy for transforming the <modify> event into a <delete> and creating this element is available in XML format in a file called `SampleSubEventTransform.xml` files in the [cred_prov folder](#) in the utilities directory on the Identity Manager media.

8 Managing Credential Provisioning





There are additional tasks you can perform to manage the Novell Credential Provisioning policies after they are implemented.

- ♦ [Section 8.1, “Managing the Repository and Application Objects,” on page 59](#)
- ♦ [Section 8.2, “Managing the Credential Provisioning Policies,” on page 60](#)

8.1 Managing the Repository and Application Objects







To manage repository and application objects (resource objects):

- 1 In the Outline view, right-click the resource object.
- 2 Select the desired task.

Option	Description
 Edit	Launches the editor for the resource object.
 Copy	Copies the selected resource object.
Export to Configuration File	Saves the resource object as a .xml file.
 Live > Deploy	Deploys the resource object into the Identity Vault.
 Live > Compare	Compares the resource object to the corresponding object in the Identity Vault.
 Delete	Deletes the selected resource object.
Properties	Lets you rename the selected resource object.

8.2 Managing the Credential Provisioning Policies

- 1 In the Outline view, right-click the policy.
- 2 Select the desired task.

Option	Description
 Edit	Launches the Policy Builder.
 Copy	Copies the selected policy.
 Save As	Saves a copy of the policy with another name.
 Simulate	Lets you test the policy in Designer before it is deployed into the Identity Vault.
Export to Configuration File	Saves the resource object as a .xml file.
 Live > Deploy	Deploys the policy into the Identity Vault.
 Live > Compare	Compares the policy to the corresponding object in the Identity Vault.
 Delete	Deletes the selected policy.
Properties	Lets you rename the selected policy.